



Brief Introduction

DEGSON was founded in 1990. DEGSON is a world-renowned manufacturer of overall solutions for industrial connectors. DEGSON'S laboratory is UL-CTDP (USA) and VDE-TDAP (Germany) dual accreditation laboratory, it is also a CNAS laboratory. The company achieved ISO9001, ISO14001, ISO80079-34, ISO/TS22163 and IATF16949 management system certifications.

DEGSON is engaged in supplying highly reliable and durable products to serve global customers. The company has a market-leading capability of mould processing, automatic manufacturing and advanced testing. DEGSON has the complete engineering ability to support global customers with the professional customization solution and value-added service.

DEGSON products are widely recognized in China, the USA, Germany, the UK, Italy, Spain, Turkey, Japan, South Korea, Singapore, etc. totally hundred countries and regions. DEGSON supply high quality products and provide professional services globally in the industry sectors likely industrial automation, instrument, electric power, railway, marine and offshore, new energy, E-bike industrial elevator, lighting, security, machinery, etc. The company won the recognition from partners among Fortune 500 and industry leading enterprises.

Based on the core values of "Clients First, Win-win Strategy, Responsibility Integrity, Excellence Pursuit", DEGSON continuously integrates professional technical resources, R&D innovation, product manufacturing and technology application capabilities. Relying on global sales network, DEGSON aims to supply series of multiple varieties of high-quality products and services. We provide global customers with professional and quick connected application solutions, help customers continue to create value. DEGSON is making contributions to creating a smart and interconnected world.



UL-CTDP (USA), VDE-TDAP (Germany) and CNAS labs

Strategic cooperation with UL and VDE



① The general manager of UL global energy & technology division visit our company

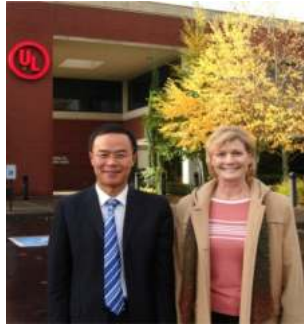

② Sven Ohrke, President of VDE global services, comes to DEGSON to discuss strategic cooperation



③ VDE Laboratory Accreditation: In July 2010, VDE Issued the "VDE Authorized Laboratory" Certificate to DEGSON' s laboratory.
 UL laboratory accreditation: UL formally issued "UL WTDP" certification to DEGSON in March 2013.
 On April, 2016, UL-CTDP.
 On December, 2016, VDE-TDAP.
 On January, 2017, Pass IRIS system audit.



ISO9001



ISO14001



CNAS



ISO/TS22163



UL - CTDP



VDE - TDAP



EX certificate



UL Certificates:10, Covering 4000+Products

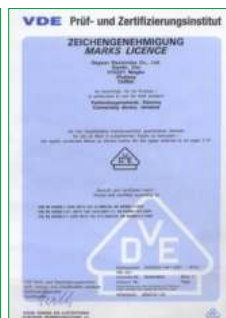

VDE Certificates:178, Covering 3000+Products



TUV certificate



EAC certificate



European invention patent

CONTENTS



DF50 series I/O 01-36



DF58 series I/O 37-68



DF20 series I/O 69-100



DFH67 Fieldbus High performance IP67 I/O 101-154



DSW Series Unmanaged switch 155-161



JB Series Junction Box 162-179



DF50 series I/O

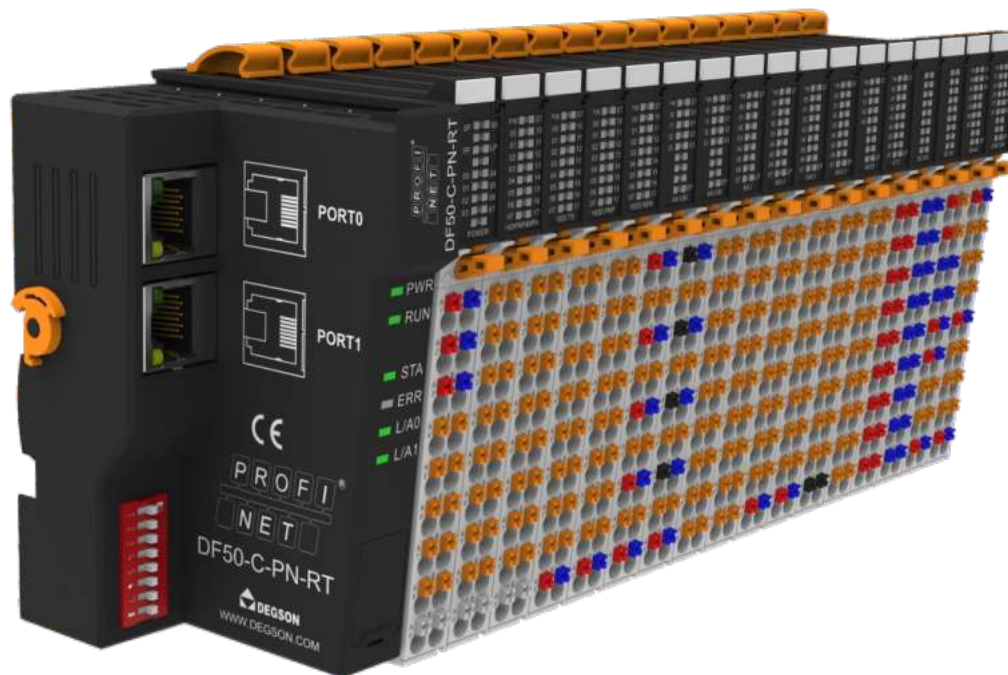

Small



Compact



Convenient

- The DF50 series I/O system is a new upgrade to the DF20 series
- Comprehensively improve I/O performance and compatibility
- Tool free use, greatly improving convenience
- The bus coupler supports 32 modules without the need for a power module

DF50 Series I/O Modules

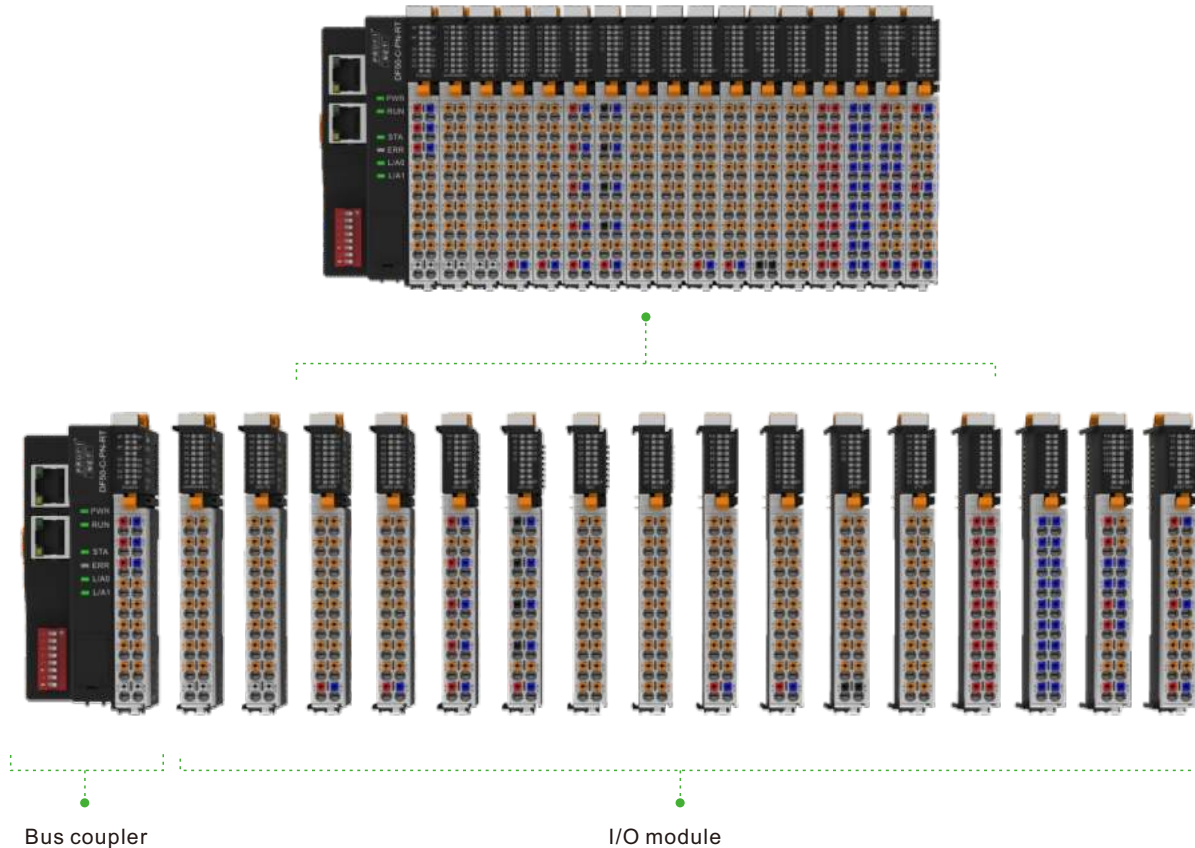

Bus coupler

- The bus coupler comes with 8 digital inputs
- Supports multiple industrial Ethernet bus protocols
- The bus coupler support 32 modules

Tool free

- No tools required for module installation and disassembly
- No tools required to install and remove front connectors
- No tools required for wiring and dismantling

I/O module

- The I/O signal is independently powered, no need to add power module
- Digital input compatible with both PNP and NPN signals
- The analog input/output module is compatible with current and voltage, supports multiple ranges and each channel can be independently selected, and supports 2, 3, and 4 wire connection methods

Appearance

- 12mm ultra-thin volume, sharp blade shape
- The module has an identification system
- The module is grounded through the back metal connection DIN-rail
- Distinguish wiring holes with different functions by color

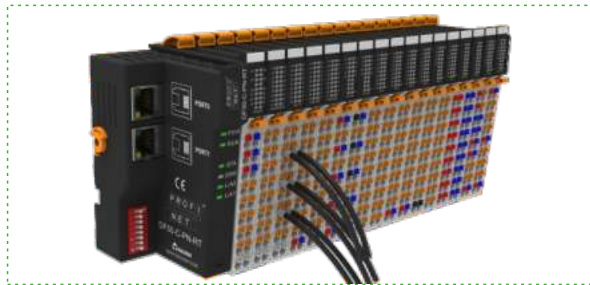
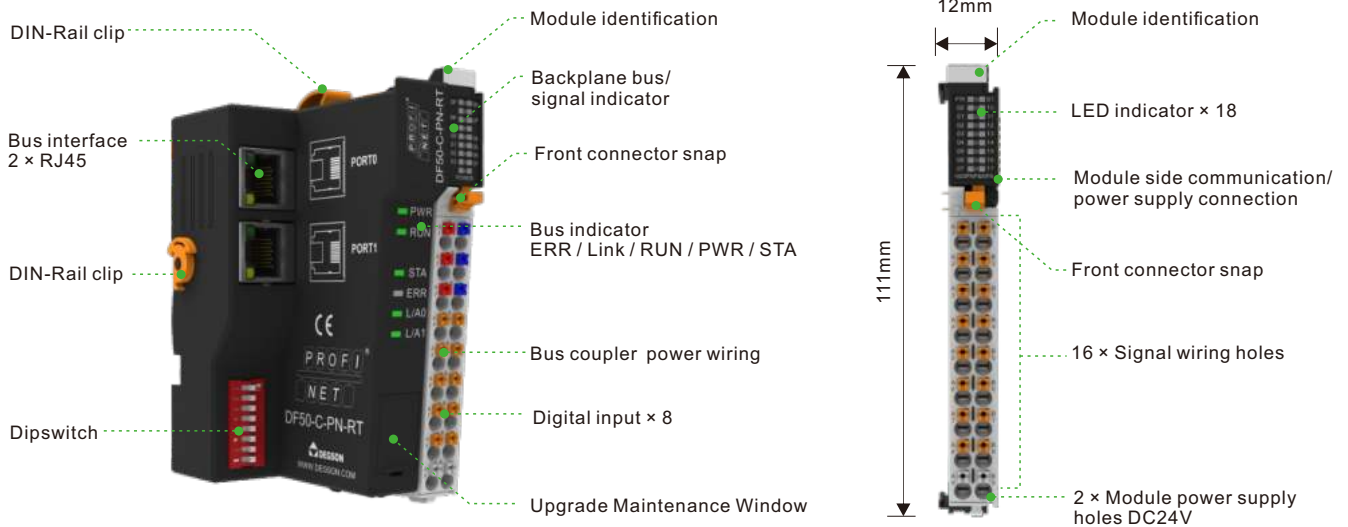

- PUSH-IN, no tools required for wire connection and disassembly



- Pluggable front connector

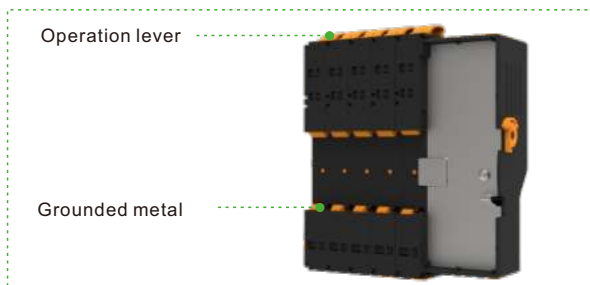

- Tool free manual operation lever
- The module is grounded through the back metal connection DIN-rail

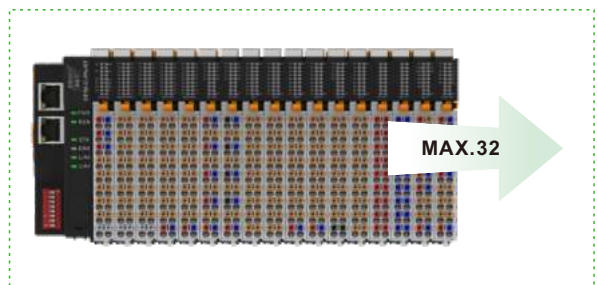

- Bus coupler can support up to 32 modules

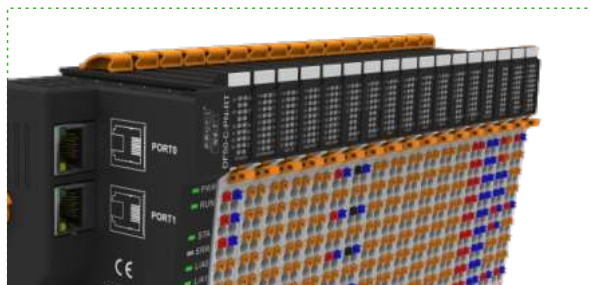

- Module has identification
- The module indicator system contains information such as signals, power, faults ...

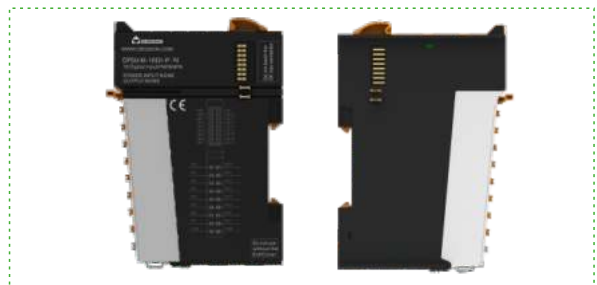

- Communication between modules through side connecting finger
- Module power supply is connected through side metal clips

PROFINET Bus coupler



DF50-C-PN-RT

PROFINET, 2 RJ45, extensible 32 modules, 24VDC

Features

- With a power module.
- LED display working status, alarm and bus fault prompt.
- Two PROFINET interface (RJ45, 10/100Mbps).
- With Media Redundancy Protocol.

Specification		Digital Inputs Specification	
Product	DF50-C-PN-RT	Number of channels	8
Communication protocol	PROFINET	Data size	1 Byte
Transmission rate	10/100Mbps, full duplex	Signal type	NPN & PNP
Transmission distance	100 meters	"0" signal voltage	<5V
PDO data	1024 bytes	"1" signal voltage	>11V
Number of extensible modules	32	Connection type	1-line
Address mapping	Yes	Reverse protection	Yes
Address setting	PROFINET specification	Isolation method	Photoelectric isolation
Transmission medium	Class 5 twisted pair cable	Fault diagnosis	Yes
Isolation method	Electrical isolation	Typical input current	0.6mA
Features	RT, conforming to Class C, MRP, automatic addressing/topology detection	Fault diagnosis	2.3mA
		Typical input current	2.1mA
Alarm function	Diagnostic alarm, process alarm, plug and unplug connector alarm	Fault diagnosis	2.4mA
		Filtering time	0.2ms-40ms configurable
Minimum cycle time	1ms	Hardware response time	200us

Power Supply Parameters

Connection type	PUSH-IN type terminal block	The minimum area of a wire (AWG)	AWG26
Working voltage	24V DC +20 %/ -15 %	Strip length	8...10mm
Working current	Max. 1.5A	Internal system rated voltage	5VDC
Maximum area of wire	1.5mm ²	Internal system rated current	2A
Maximum area of wire (AWG)	AWG16	Output power supply voltage	24V(20.4VDC~28.8VDC)
The minimum area of a wire	0.14mm ²	Output power supply current	Max. 0.75A

PROFINET Bus coupler



Product	DF50-C-PN-RT
Mechanical	Structure
Protection grade	IP20
Size(H X W X D)	111mm X 48mm X 75mm
Installation type	35mm DIN

Work Environment

Working temperature	-25...60°C
Storage temperature	-40...85°C
Relative humidity	5...95%RH(non-condensing)

LED Status Indicator

PWR	Green: Power is working
RUN	Green: I/O system is running
STA	Blinking green: The module is working
ERR	Red: An error occurred between I/O system and module
L/A0	Green : PORT 1 connected successfully.
	Green blinking : Port 1 has data communication.
L/A1	Green : PORT 2 connected successfully.
	Green blinking : Port 2 has data communication.
Sys 24v	Green:The system power input is normal
Sys 5v	Green: The system power output is normal
Feild 24v	Green:Load power input is normal
Load 24v	Green: The load power output is normal

Wiring Diagram

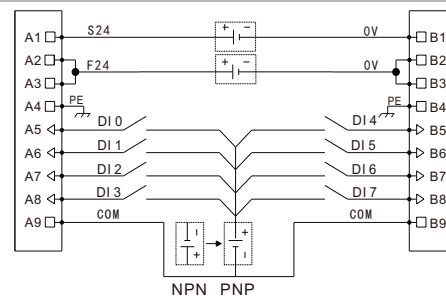
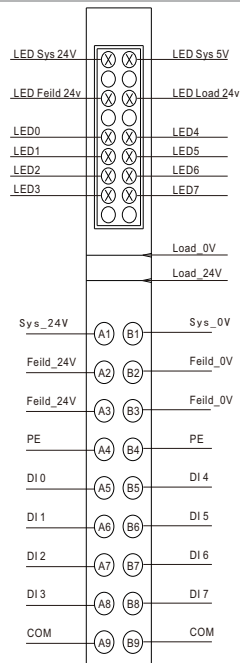

PIN definition

Mark	Description	Mark	Description
A1	Sys_24V	B1	Sys_0V
A2	Feild_24V	B2	Feild_0V
A3	Feild_24V	B3	Feild_0V
A4	PE	B4	PE
A5	input 0	B5	input 4
A6	input 1	B6	input 5
A7	input 2	B7	input 6
A8	input 3	B8	input 7
A9	COM	B9	COM

COM is the common terminal of DI0~DI7, connected to 24V is NPN, and connected to 0V is PNP

EtherCAT Bus coupler



RoHS



DF50-C-EC

EtherCAT, 2 RJ45, extensible 32 modules, 24VDC

Features

- With a power module.
- LED display working status, alarm and bus fault prompt.
- Two EtherCAT interface (RJ45, 100Mbps).

Specification		Digital Inputs Specification	
Product	DF50-C-EC	Number of channels	8
Communication protocol	EtherCAT	Data size	1 Byte
Transmission rate	10/100Mbps, full duplex	Signal type	NPN & PNP
Transmission distance	100 meters	"0" signal voltage	<5V
PDO data	1024 bytes	"1" signal voltage	>11V
Number of extensible modules	32	Connection type	1-line
Address mapping	Yes	Reverse protection	Yes
Address setting	EtherCAT specification, DIP switch	Isolation method	Photoelectric isolation
Transmission medium	Class 5 twisted pair cable	Fault diagnosis	Yes
Isolation method	Electrical isolation	Typical input current	0.6mA
Features	1ms	Fault diagnosis	2.3mA
		Typical input current	2.1mA
Alarm function	Diagnostic alarm, process alarm, plug and unplug connector alarm	Fault diagnosis	2.4mA
		Filtering time	0.2ms-40ms configurable
Minimum cycle time	2 X RJ45, with switch function	Hardware response time	200us

Power Supply Parameters

Connection type	PUSH-IN type terminal block	The minimum area of a wire (AWG)	AWG26
Working voltage	24V DC +20 %/ -15 %	Strip length	8...10mm
Working current	Max. 1.5A	Internal system rated voltage	5VDC
Maximum area of wire	1.5mm ²	Internal system rated current	2A
Maximum area of wire (AWG)	AWG16	Output power supply voltage	24V(20.4VDC-28.8VDC)
The minimum area of a wire	0.14mm ²	Output power supply current	Max. 0.75A

EtherCAT Bus coupler



Product	DF50-C-EC
---------	-----------

Mechanical

Protection grade	IP20
Size(H X W X D)	111mm X 48mm X 75mm
Installation type	35mm DIN

Work Environment

Working temperature	-25...60°C
Storage temperature	-40...85°C
Relative humidity	5...95%RH(non-condensing)

LED Status Indicator

PWR	Green: Power is working
RUN	Green: I/O system is running
STA	Blinking green: The module is working
ERR	Red: An error occurred between I/O system and module
L/A0	Green : PORT 1 connected successfully.
	Green blinking : Port 1 has data communication.
L/A1	Green : PORT 2 connected successfully.
	Green blinking : Port 2 has data communication.
Sys 24v	Green:The system power input is normal
Sys 5v	Green: The system power output is normal
Feild 24v	Green:Load power input is normal
Load 24v	Green: The load power output is normal

Wiring Diagram

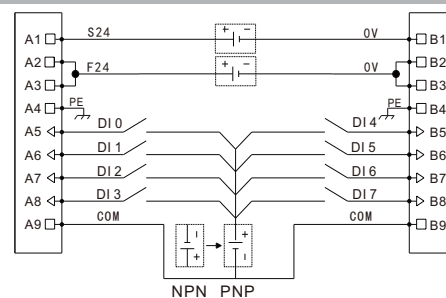
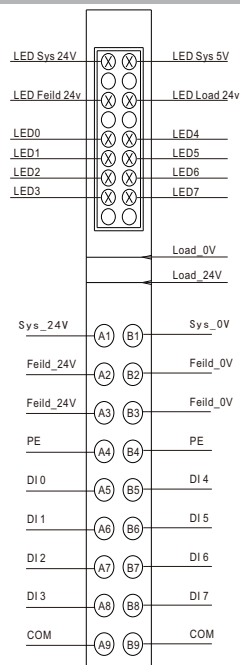

PIN definition

Mark	Description	Mark	Description
A1	Sys_24V	B1	Sys_0V
A2	Feild_24V	B2	Feild_0V
A3	Feild_24V	B3	Feild_0V
A4	PE	B4	PE
A5	input 0	B5	input 4
A6	input 1	B6	input 5
A7	input 2	B7	input 6
A8	input 3	B8	input 7
A9	COM	B9	COM

COM is the common terminal of DI0~DI7, connected to 24V is NPN, and connected to 0V is PNP

DF50-M-16DI-P/N

Digital input module, 16 ports, PNP, 24VDC

Specification

Product	DF50-M-16DI-P/N
Number of channels	16
Data size	2 Byte
Signal type	NPN & PNP
"0" signal voltage	>11V
"1" signal voltage	<5V
Connection type	1-line, Type 1/Type 3, Refer to IEC 61131-2
Reverse protection	Yes
Isolation method	Photoelectric isolation
Fault diagnosis	Yes
Typical input current	0.6mA
Fault diagnosis	2.3mA
Typical input current	2.1mA
Fault diagnosis	2.4mA
Filtering time	0.2ms-40ms configurable,
Hardware response time	200us

Power Supply Parameters

Connection type	PUSH-IN type terminal block
Working voltage	24V DC +20 %/ -15 %
System feed current	<30mA
Maximum area of wire	1.5mm ²
Maximum area of wire (AWG)	AWG16
The minimum area of a wire	0.14mm ²
The minimum area of a wire (AWG)	AWG26
Strip length	8...10mm

Digital input module



Product DF50-M-16DI-P/N

Mechanical Structure

Protection grade IP20
 Size(H X W X D) 111mm X 12mm X 75mm
 Installation type 35mm DIN

Work Environment

Working temperature -25...60°C
 Storage temperature -40...85°C
 Relative humidity 5...95%RH(non-condensing)

LED Status Indicator

PW Green: Internal bus power supply is normal
 ST Power on stage: green on: module initialization abnormal, green off: module initialization normal
 Operation phase: Green flashing: The internal bus of the module is working normally, green off: The internal bus of the module is working abnormally
 LED Green: input signal is valid

Wiring Diagram

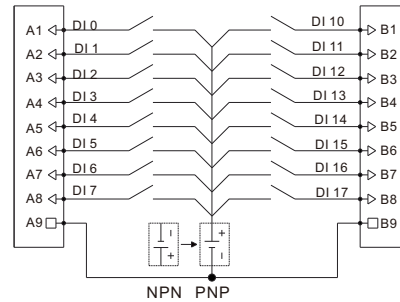
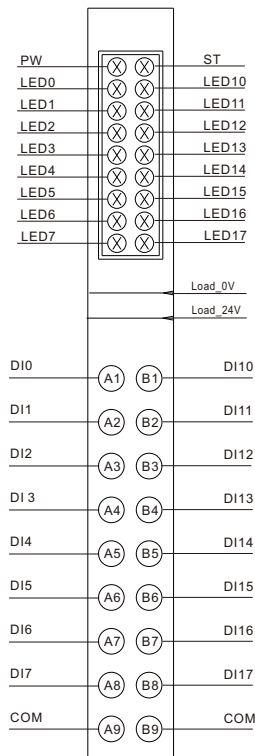

PIN definition

Mark	Description	Mark	Description
A1	input 0	B1	input 10
A2	input 1	B2	input 11
A3	input 2	B3	input 12
A4	input 3	B4	input 13
A5	input 4	B5	input 14
A6	input 5	B6	input 15
A7	input 6	B7	input 16
A8	input 7	B8	input 17
A9	COM	B9	COM

COM is the common terminal of DI0~DI17, connected to 24V is NPN, and connected to 0V is PNP

Digital output module



RoHS

DF50-M-16DO-N

Digital output module, 16 ports, NPN, 24VDC

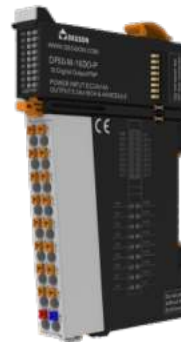
DF50-M-16DO-P

Digital output module, 16 ports, PNP, 24VDC

Specification

Product	DF50-M-16DO-N	DF50-M-16DO-P
Number of channels	16	
Data size	2 Byte	
Signal type	NPN	PNP
"0" signal voltage	high-impedance state	high-impedance state
"1" signal voltage	0V DC	24V DC
Connection type	1-line	
Reverse protection	Yes	
Isolation method	Photoelectric isolation	
Switching Frequency (resistance/lamp load)	<1000Hz	
Switching Frequency (Inductive load)	<0.2Hz	
Response Time of the Protection Circuit	< 100µs	
Output current per channel(MAX)	500 mA	
Load type	Inductive (7.2W/point, 24W/module), resistive (0.5A/point, 4A/module), light (5W/point, 18W/module)	

Power Supply Parameters

Connection type	PUSH-IN type terminal block	
Working voltage	24V DC +20 %/ -15 %	
System feed current	<75mA	<100mA
Maximum area of wire	1.5mm ²	
Maximum area of wire (AWG)	AWG16	
The minimum area of a wire	0.14mm ²	
The minimum area of a wire (AWG)	AWG26	
Strip length	8...10mm	

Digital output module



Product	DF50-M-16DO-N	DF50-M-16DO-P
---------	---------------	---------------

Mechanical Structure

Protection grade	IP20
Size(H X W X D)	111mm X 12mm X 75mm
Installation type	35mm DIN

Work Environment

Working temperature	-25...60°C
Storage temperature	-40...85°C
Relative humidity	5...95%RH(non-condensing)

LED Status Indicator

PW	Green: Internal bus power supply is normal
ST	Power on stage: green on: module initialization abnormal, green off: module initialization normal
	Operation phase: Green flashing: The internal bus of the module is working normally, green off: The internal bus of the module is working abnormally
LED	Green: input signal is valid

Wiring Diagram

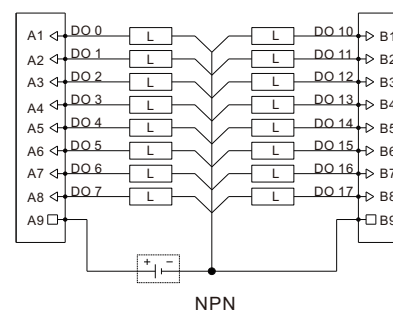
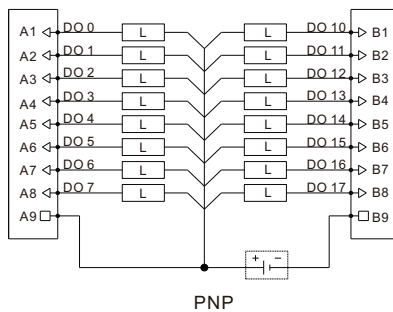
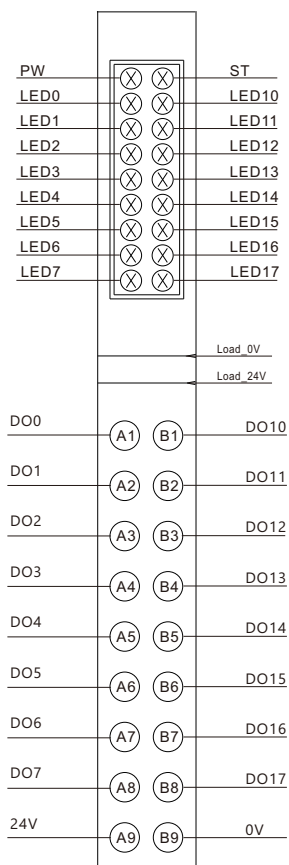

PIN definition

Mark	Description	Mark	Description
A1	output 0	B1	output 10
A2	output 1	B2	output 11
A3	output 2	B3	output 12
A4	output 3	B4	output 13
A5	output 4	B5	output 14
A6	output 5	B6	output 15
A7	output 6	B7	output 16
A8	output 7	B8	output 17
A9	24V	B9	0V

DF50-M-4AI-UI-6

Analog input module, 4 channels, voltage type, current type

Specification

Product	DF50-M-4AI-UI-6
Number of channels	4
Data size	8 Byte
Voltage test range	$\pm 10V$, 0-10V, 2-10V, $\pm 5V$, 0-5V, 1-5V
Current test range	0-20mA, 4-20mA
Connection type	2/3/4-line
Reverse protection	Yes
Isolation method	Magnetic isolation
Fault diagnosis	Yes
Diagnostic reporting	Yes
Resolution	16 Bit
Signal type	/
Filter parameter configuration	/
Input accuracy	$\pm 0.20\%$
Conversion time	60us/channel
Sampling time	4-channel 250us

Power Supply Parameters

Connection type	PUSH-IN type terminal block
Working voltage	24V DC +20 %/ -15 %
System feed current	<120mA
Maximum area of wire	1.5mm ²
Maximum area of wire (AWG)	AWG16
The minimum area of a wire	0.14mm ²
The minimum area of a wire (AWG)	AWG26
Strip length	8...10mm

Analog input module



Product DF50-M-4AI-UI-6

Mechanical Structure

Protection grade IP20
 Size(H X W X D) 111mm X 12mm X 75mm
 Installation type 35mm DIN

Work Environment

Working temperature -25...60°C
 Storage temperature -40...85°C
 Relative humidity 5... 95%RH(non-condensing)

LED Status Indicator

PW Green: Internal bus power supply is normal
 ST Power on stage: green on: module initialization abnormal, green off: module initialization normal
 Operation phase: Green flashing: The internal bus of the module is working normally, green off: The internal bus of the module is working abnormally
 LED Green flashing: channel sampling is normal; Green off: signal is 0
 EP Green: External interface power supply is normal

Wiring Diagram

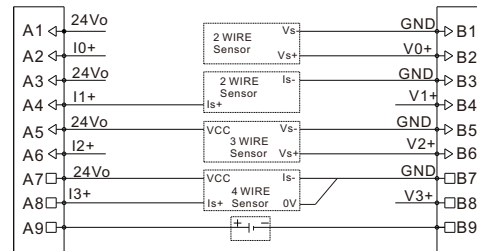
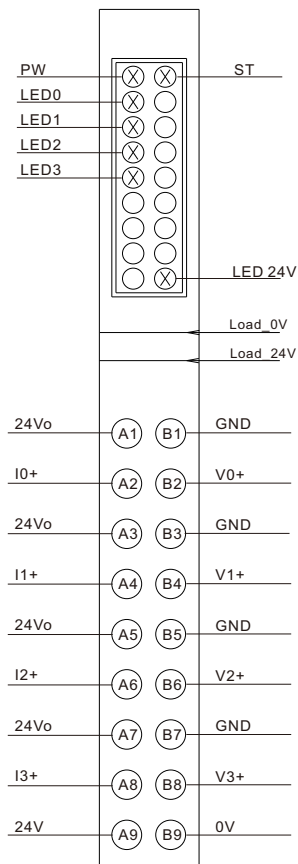

PIN definition

Mark	Description	Mark	Description
A1	24Vo	B1	GND
A2	Current input 0+	B2	Voltage input 0+
A3	24Vo	B3	GND
A4	Current input 1+	B4	Voltage input 1+
A5	24Vo	B5	GND
A6	Current input 2+	B6	Voltage input 2+
A7	24Vo	B7	GND
A8	Current input 3+	B8	Voltage input 3+
A9	Load_24V	B9	Load_0V

DF50-M-8AI-U-4

Analog input module, 8 channels, voltage type

Specification

Product	DF50-M-8AI-U-4
Number of channels	8
Data size	16 Byte
Voltage test range	$\pm 10V$, 0-10V, 2-10V, $\pm 5V$, 0-5V, 1-5V
Connection type	2-line
Reverse protection	Yes
Isolation method	Magnetic isolation
Fault diagnosis	Yes
Diagnostic reporting	Yes
Resolution	16 Bit
Signal type	single-ended
Filter parameter configuration	The software filtering time can be configured through the upper computer
Input accuracy	$\pm 0.20\%$
Conversion time	60us/channel
Sampling time	8-channel 500us

Power Supply Parameters

Connection type	PUSH-IN type terminal block
Working voltage	24V DC +20 %/ -15 %
System feed current	<120mA
Maximum area of wire	1.5mm ²
Maximum area of wire (AWG)	AWG16
The minimum area of a wire	0.14mm ²
The minimum area of a wire (AWG)	AWG26
Strip length	8...10mm

Analog input module



Product DF50-M-8AI-U-4

Mechanical Structure

Protection grade IP20
 Size(H X W X D) 111mm X 12mm X 75mm
 Installation type 35mm DIN

Work Environment

Working temperature -25...60°C
 Storage temperature -40...85°C
 Relative humidity 5... 95%RH(non-condensing)

LED Status Indicator

PW Green: Internal bus power supply is normal
 ST Power on stage: green on: module initialization abnormal, green off: module initialization normal
 Operation phase: Green flashing: The internal bus of the module is working normally, green off: The internal bus of the module is working abnormally
 LED Green flashing: channel sampling is normal; Green off: signal is 0
 LP Green: Internal system power supply is normal

Wiring Diagram

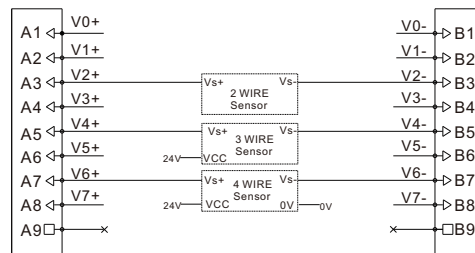
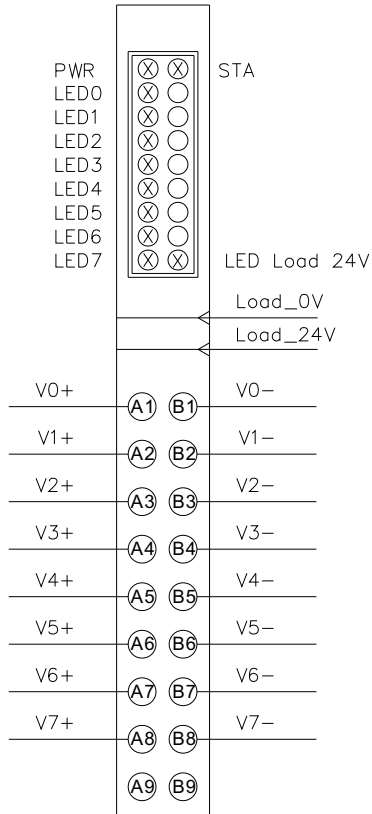

PIN definition

Mark	Description	Mark	Description
A1	Voltage input 0+	B1	Voltage input 0-
A2	Voltage input 1+	B2	Voltage input 1-
A3	Voltage input 2+	B3	Voltage input 2-
A4	Voltage input 3+	B4	Voltage input 3-
A5	Voltage input 4+	B5	Voltage input 4-
A6	Voltage input 5+	B6	Voltage input 5-
A7	Voltage input 6+	B7	Voltage input 6-
A8	Voltage input 7+	B8	Voltage input 7-
A9	/	B9	/

DF50-M-8AI-I-5

Analog input module, 8 channels, current type

Specification

Product	DF50-M-8AI-I-5
Number of channels	8
Data size	16 Byte
Current test range	0-20mA, 4-20mA
Connection type	2-line
Reverse protection	Yes
Isolation method	Magnetic isolation
Fault diagnosis	Yes
Diagnostic reporting	Yes
Resolution	16 Bit
Signal type	single-ended
Filter parameter configuration	The software filtering time can be configured through the upper computer
Input accuracy	±0.20%
Conversion time	60us/channel
Sampling time	8-channel 500us

Power Supply Parameters

Connection type	PUSH-IN type terminal block
Working voltage	24V DC +20 %/ -15 %
System feed current	<120mA
Maximum area of wire	1.5mm ²
Maximum area of wire (AWG)	AWG16
The minimum area of a wire	0.14mm ²
The minimum area of a wire (AWG)	AWG26
Strip length	8...10mm

Analog input module



Product DF50-M-8AI-I-5

Mechanical Structure

Protection grade IP20
 Size(H X W X D) 111mm X 12mm X 75mm
 Installation type 35mm DIN

Work Environment

Working temperature -25...60°C
 Storage temperature -40...85°C
 Relative humidity 5... 95%RH(non-condensing)

LED Status Indicator

PW Green: Internal bus power supply is normal
 ST Power on stage: green on: module initialization abnormal, green off: module initialization normal
 Operation phase: Green flashing: The internal bus of the module is working normally, green off: The internal bus of the module is working abnormally
 LED Green flashing: channel sampling is normal; Green off: signal is 0
 LP Green: Internal system power supply is normal

Wiring Diagram

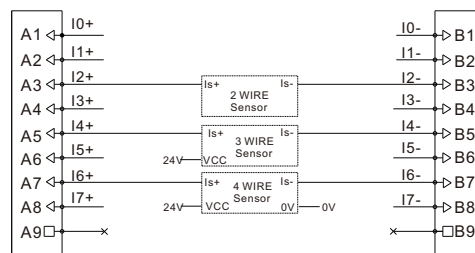
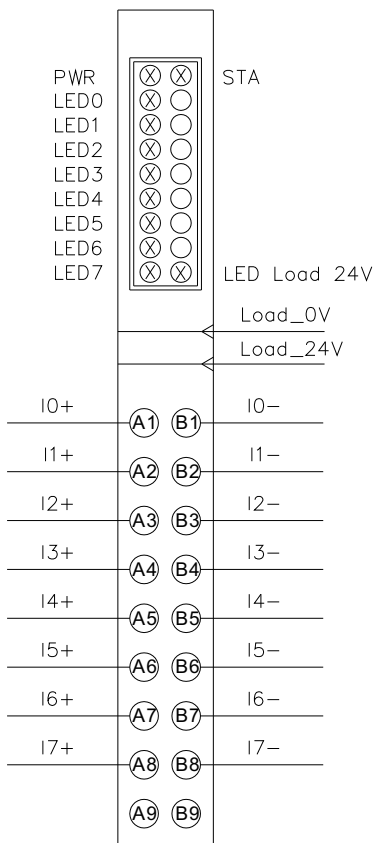

PIN definition

Mark	Description	Mark	Description
A1	Current input 0+	B1	Current input 0-
A2	Current input 1+	B2	Current input 1-
A3	Current input 2+	B3	Current input 2-
A4	Current input 3+	B4	Current input 3-
A5	Current input 4+	B5	Current input 4-
A6	Current input 5+	B6	Current input 5-
A7	Current input 6+	B7	Current input 6-
A8	Current input 7+	B8	Current input 7-
A9	/	B9	/

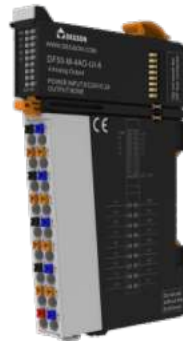
DF50-M-4AO-UI-6

Analog output module, 4 channels, voltage type, current type

Specification

Product	DF50-M-4AO-UI-6
Number of channels	4
Data size	8 Byte
Voltage output range	$\pm 10V$, 0-10V, 2-10V, $\pm 5V$, 0-5V, 1-5V
Current output range	0-20mA, 4-20mA
Signal type	single-ended
Connection type	2/3/4-line
Overcurrent protection	Yes
Isolation method	Magnetic isolation
Fault diagnosis	Yes
Resolution	16 Bit
Output accuracy	$\pm 0.50\%$
Temperature coefficient	<30 ppm/K
Independent channel configuration	Yes
Conversion time	60us/channel

Power Supply Parameters

Connection type	PUSH-IN type terminal block
Working voltage	24V DC +20 %/ -15 %
System feed current	<110mA
Maximum area of wire	1.5mm ²
Maximum area of wire (AWG)	AWG16
The minimum area of a wire	0.14mm ²
The minimum area of a wire (AWG)	AWG26
Strip length	8...10mm

Analog output module



Product DF50-M-4AO-UI-6

Mechanical Structure

Protection grade	IP20
Size(H X W X D)	111mm X 12mm X 75mm
Installation type	35mm DIN

Work Environment

Working temperature	-25...60°C
Storage temperature	-40...85°C
Relative humidity	5... 95%RH(non-condensing)

LED Status Indicator

PW	Green: Internal bus power supply is normal
ST	Power on stage: green on: module initialization abnormal, green off: module initialization normal
	Operation phase: Green flashing: The internal bus of the module is working normally, green off: The internal bus of the module is working abnormally
LED	Green flashing: channel sampling is normal; Green off: signal is 0
EP	Green: External interface power supply is normal

Wiring Diagram

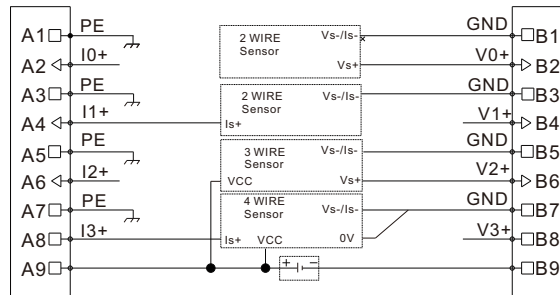
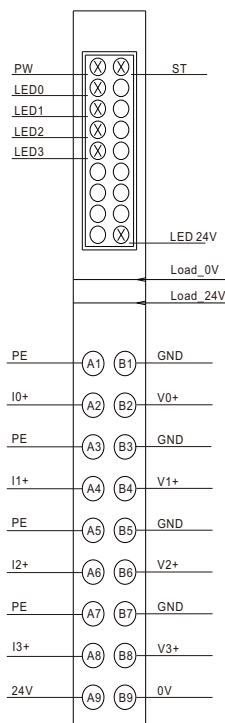

PIN definition

Mark	Description	Mark	Description
A1	PE	B1	GND
A2	Current output 0+	B2	Voltage output 0+
A3	PE	B3	GND
A4	Current output 1+	B4	Voltage output 1+
A5	PE	B5	GND
A6	Current output 2+	B6	Voltage output 2+
A7	PE	B7	GND
A8	Current output 3+	B8	Voltage output 3+
A9	Load_24V	B9	Load_0V

DF50-M-8AO-U-4

Analog output module, 8 channels, voltage type

Specification

Product	DF50-M-8AO-U-4
Number of channels	8
Data size	16 Byte
Voltage output range	$\pm 10V$, 0-10V, 2-10V, $\pm 5V$, 0-5V, 1-5V
Signal type	single-ended
Connection type	2-line
Overcurrent protection	Yes
Isolation method	Magnetic isolation
Fault diagnosis	Yes
Resolution	16 Bit
Output accuracy	$\pm 0.50\%$
Temperature coefficient	<30 ppm/K
Independent channel configuration	Yes
Conversion time	60us/channel

Power Supply Parameters

Connection type	PUSH-IN type terminal block
Working voltage	24V DC +20 %/ -15 %
System feed current	<110mA
Maximum area of wire	1.5mm ²
Maximum area of wire (AWG)	AWG16
The minimum area of a wire	0.14mm ²
The minimum area of a wire (AWG)	AWG26
Strip length	8...10mm

Analog output module



Product	DF50-M-8AO-U-4
---------	----------------

Mechanical Structure

Protection grade	IP20
Size(H X W X D)	111mm X 12mm X 75mm
Installation type	35mm DIN

Work Environment

Working temperature	-25...60°C
Storage temperature	-40...85°C
Relative humidity	5... 95%RH(non-condensing)

LED Status Indicator

PW	Green: Internal bus power supply is normal
ST	Power on stage: green on: module initialization abnormal, green off: module initialization normal
	Operation phase: Green flashing: The internal bus of the module is working normally, green off: The internal bus of the module is working abnormally
LED	Green flashing: channel sampling is normal; Green off: signal is 0
EP	Green: External interface power supply is normal

Wiring Diagram

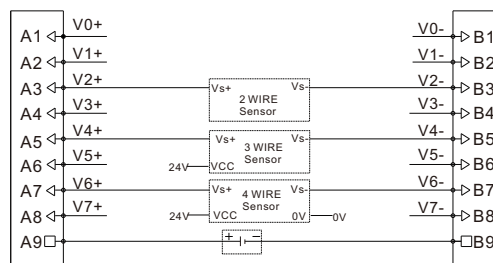
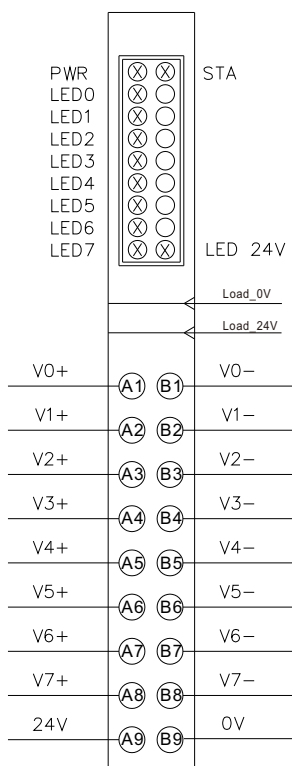

PIN definition

Mark	Description	Mark	Description
A1	Voltage input 0+	B1	Voltage input 0-
A2	Voltage input 1+	B2	Voltage input 1-
A3	Voltage input 2+	B3	Voltage input 2-
A4	Voltage input 3+	B4	Voltage input 3-
A5	Voltage input 4+	B5	Voltage input 4-
A6	Voltage input 5+	B6	Voltage input 5-
A7	Voltage input 6+	B7	Voltage input 6-
A8	Voltage input 7+	B8	Voltage input 7-
A9	/	B9	/

DF50-M-8AO-I-5

Analog output module, 8 channels, current type

Specification

Product	DF50-M-8AO-I-5
Number of channels	8
Data size	16 Byte
Current output range	0-20mA,4-20mA
Signal type	single-ended
Connection type	2-line
Overcurrent protection	Yes
Isolation method	Magnetic isolation
Fault diagnosis	Yes
Resolution	16 Bit
Output accuracy	±0.50%
Temperature coefficient	<30 ppm/K
Independent channel configuration	Yes
Conversiontime	60us/channel

Power Supply Parameters

Connection type	PUSH-IN type terminal block
Working voltage	24V DC +20 %/ -15 %
System feed current	<110mA
Maximum area of wire	1.5mm ²
Maximum area of wire (AWG)	AWG16
The minimum area of a wire	0.14mm ²
The minimum area of a wire (AWG)	AWG26
Strip length	8...10mm

Analog output module



Product	DF50-M-8AO-I-5
Mechanical Structure	
Protection grade	IP20
Size(H X W X D)	111mm X 12mm X 75mm
Installation type	35mm DIN
Work Environment	
Working temperature	-25...60°C
Storage temperature	-40...85°C
Relative humidity	5... 95%RH(non-condensing)
LED Status Indicator	
PW	Green: Internal bus power supply is normal
ST	Power on stage: green on: module initialization abnormal, green off: module initialization normal
	Operation phase: Green flashing: The internal bus of the module is working normally, green off: The internal bus of the module is working abnormally
LED	Green flashing: channel sampling is normal; Green off: signal is 0
EP	Green: External interface power supply is normal
Wiring Diagram	

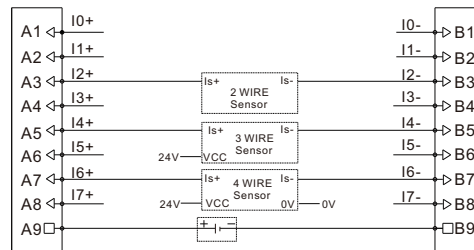
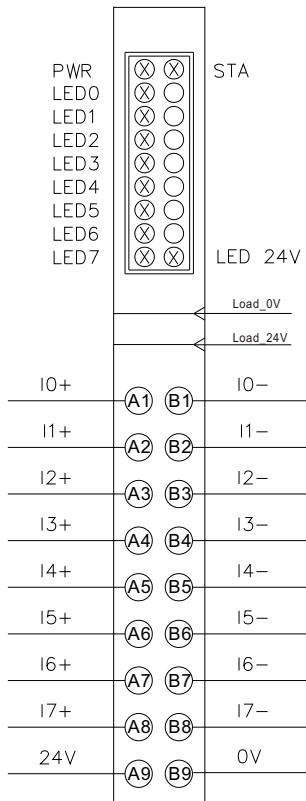

PIN definition

Mark	Description	Mark	Description
A1	Voltage output 0+	B1	Voltage output 0-
A2	Voltage output 1+	B2	Voltage output 1-
A3	Voltage output 2+	B3	Voltage output 2-
A4	Voltage output 3+	B4	Voltage output 3-
A5	Voltage output 4+	B5	Voltage output 4-
A6	Voltage output 5+	B6	Voltage output 5-
A7	Voltage output 6+	B7	Voltage output 6-
A8	Voltage output 7+	B8	Voltage output 7-
A9	Load_24V	B9	Load_0V

DF50-M-4RTD-PT

Thermal Resistance (RTD) measurement module,
16 bit resolution, 4 channels

Specification

Product	DF50-M-4RTD-PT
Number of channels	4
Data size	8 Byte
Signal type	Thermal resistance
Signal type	Pt100, Pt200, Pt500, Pt1000, Ni100, Ni120, Ni 200, Ni500, Ni1000, Cu10, 40 Ω, 80 Ω, 150 Ω, 300 Ω, 500 Ω, 1 kΩ, 2 kΩ, 4 kΩ
Connection type	2/3/4-line
Reverse protection	Yes
Isolation method	Magnetic isolation between each channel and the field layer, and isolation between channels
Fault diagnosis	Yes
Resolution	16bit, 0.1°C/ each number
Frequency interference suppression	50Hz 60Hz 400Hz
Diagnosis	Disconnection, Parameter assignment error
Process alarm	Upper/Lower limit, per channel
Temperature coefficient	±50ppm/K max.
Measuring range	Thermal resistance
Precision	'max. 0.2 % FSR / 0.3 % FSR for Ni sensors / 0.6 % FSR for Cu10
Conversion time	100-800ms, configurable

Temperature module



Product DF50-M-4RTD-PT

Power Supply Parameters

Connection type	PUSH-IN type terminal block
Working voltage	24V DC +20 %/ -15 %
System feed current	<100mA
Maximum area of wire	1.5mm ²
Maximum area of wire (AWG)	AWG16
The minimum area of a wire	0.14mm ²
The minimum area of a wire (AWG)	AWG26
Strip length	8...10mm

Mechanical Structure

Protection grade	IP20
Size(H X W X D)	111mm X 12mm X 75mm
Installation type	35mm DIN

Work Environment

Working temperature	-25...60°C
Storage temperature	-40...85°C
Relative humidity	5... 95%RH(non-condensing)

LED Status Indicator

PW	Green: Internal bus power supply is normal
ST	Power on stage: green on: module initialization abnormal, green off: module initialization normal
	Operation phase: Green flashing: The internal bus of the module is working normally, green off: The internal bus of the module is working abnormally
LED	Green flashing: channel sampling is normal; Green off: signal is 0

Wiring Diagram

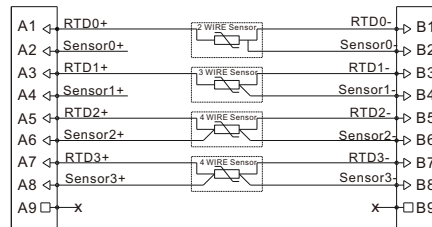
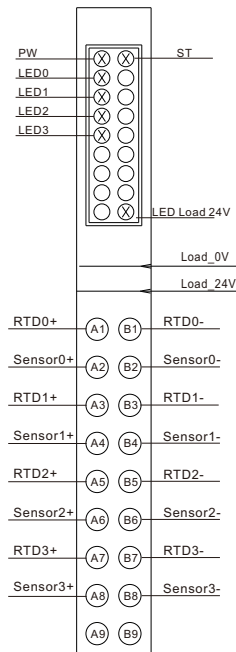

PIN definition

Mark	Description	Mark	Description
A1	RTD0+	B1	RTD0-
A2	Sensor0+	B2	Sensor0-
A3	RTD1+	B3	RTD1-
A4	Sensor1+	B4	Sensor1-
A5	RTD2+	B5	RTD2-
A6	Sensor2+	B6	Sensor2-
A7	RTD3+	B7	RTD3-
A8	Sensor3+	B8	Sensor3-
A9	/	B9	/

DF50-M-8TC

 Thermocouple (TC) measurement module,
 16 bit resolution, 8 channels

Specification

Product	DF50-M-8TC
Number of channels	8
Data size	16 Byte
Signal type	Thermocouple
Signal type	K, E, T, J, B, S, R, N, C, L
Cold End compensation	Internal and external (accuracy $\leq 3K$)
Diagnosis	Yes
Temperature coefficient	≤ 50 ppm/K
Connection type	2-line
Reverse protection	Yes
Isolation method	Magnetic isolation
Fault diagnosis	Yes
Internal Resistance	/
Resolution	16bit, 0.1°C/ resolution
Frequency interference suppression	10Hz 50Hz 60Hz 400Hz
Diagnosis	Disconnection, Parameter assignment error
Process alarm	Upper/Lower limit, per channel
Temperature coefficient	$\pm 0.5\%$
Measuring range	-270°C ~ 1370°C
Precision	$\pm 0.3\%$
Conversion time	125ms

Temperature module



Product	DF50-M-8TC
---------	------------

Power Supply Parameters

Connection type	PUSH-IN type terminal block
Working voltage	24V DC +20 %/ -15 %
System feed current	<100mA
Maximum area of wire	1.5mm ²
Maximum area of wire (AWG)	AWG16
The minimum area of a wire	0.14mm ²
The minimum area of a wire (AWG)	AWG26
Strip length	8...10mm

Mechanical Structure

Protection grade	IP20
Size(H X W X D)	111mm X 12mm X 75mm
Installation type	35mm DIN

Work Environment

Working temperature	-25...60°C
Storage temperature	-40...85°C
Relative humidity	5... 95%RH(non-condensing)

LED Status Indicator

PW	Green: Internal bus power supply is normal
ST	Power on stage: green on: module initialization abnormal, green off: module initialization normal
	Operation phase: Green flashing: The internal bus of the module is working normally, green off: The internal bus of the module is working abnormally
LED	Green flashing: channel sampling is normal; Green off: signal is 0
LP	Green: Internal system power supply is normal

Wiring Diagram

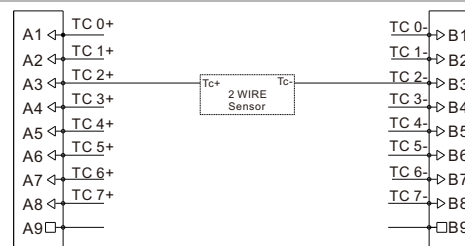
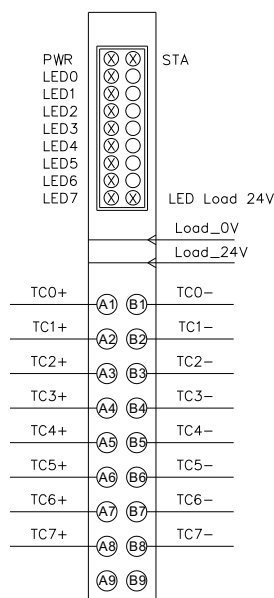

PIN definition

Mark	Description	Mark	Description
A1	Thermocouple input 0+	B1	Thermocouple input 0-
A2	Thermocouple input 1+	B2	Thermocouple input 1-
A3	Thermocouple input 2+	B3	Thermocouple input 2-
A4	Thermocouple input 3+	B4	Thermocouple input 3-
A5	Thermocouple input 4+	B5	Thermocouple input 4-
A6	Thermocouple input 5+	B6	Thermocouple input 5-
A7	Thermocouple input 6+	B7	Thermocouple input 6-
A8	Thermocouple input 7+	B8	Voltage input 7-
A9	/	B9	/

DF50-M-2CNT-PIL-24

24V Pulse counting module, 2 channel

Specification

Product	DF50-M-2CNT-PIL-24
Maximum frequency count	1Mhz
Number of channels	2
Data size	20 Byte
Input signal type	Incremental encoder AB or pulse/direction signal
Input signal type	24V DC
Input connection type	2-line / 4-line
Filtering time	0.01 to 1 ms
Reverse protection	Yes
Isolation method	Isolate from the field layer optocoupler
Fault diagnosis	Yes, us response, error code can be queried by upper computer
Resolution	32 Bit
Precision	±1 pulse

Power Supply Parameters

Connection type	PUSH-IN type terminal block
System feed current	<100mA
Maximum area of wire	1.5mm ²
Maximum area of wire (AWG)	AWG16
The minimum area of a wire	0.14mm ²
The minimum area of a wire (AWG)	AWG26
Strip length	8...10mm

Pulse counting module



Product	DF50-M-2CNT-PIL-24
Mechanical Structure	
Protection grade	IP20
Size(H X W X D)	111mm X 12mm X 75mm
Installation type	35mm DIN
Work Environment	
Working temperature	-25...60°C
Storage temperature	-40...85°C
Relative humidity	5...95%RH(non-condensing)

LED Status Indicator	
PW	Green: Internal bus power supply is normal
ST	Power on stage: green on: module initialization abnormal, green off: module initialization normal
	Operation phase: Green flashing: The internal bus of the module is working normally, green off: The internal bus of the module is working abnormally
TP1/TP2	On: Input signal valid Off: Input signal invalid
A1/A2	On: Input signal valid Off: Input signal invalid
B1/B2	On: Input signal valid Off: Input signal invalid
UP1/UP2	On: Encoder forward rotation off: Encoder stationary or reverse rotation
DN1/DN2	On: Encoder reverse rotation off: Encoder stationary or forward rotation
LED 24V	On: Module external interface power supply is normal Off: Module external interface power supply is abnormal

Wiring Diagram

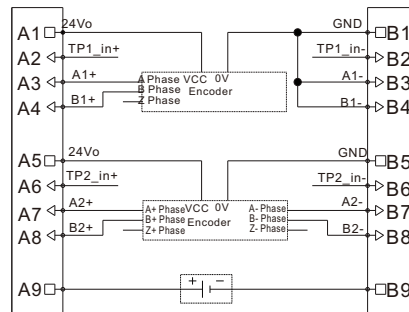
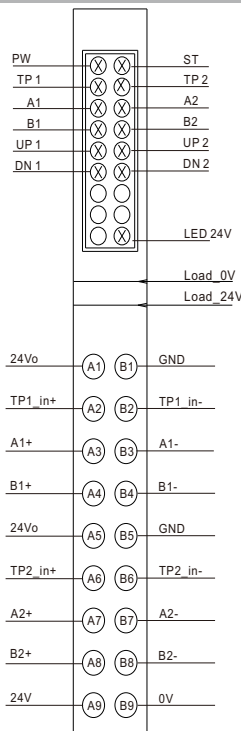

PIN definition

Mark	Description	Mark	Description
A1	24Vo	B1	GND
A2	TP1_in+ signal	B2	TP1_in- signal
A3	A1+ Phase	B3	A1- Phase
A4	B1+ Phase	B4	B1- Phase
A5	24Vo	B5	GND
A6	TP2_in+ signal	B6	TP2_in- signal
A7	A2+ Phase	B7	A2- Phase
A8	B2+ Phase	B8	B2- Phase
A9	Load_24V	B9	Load_0V

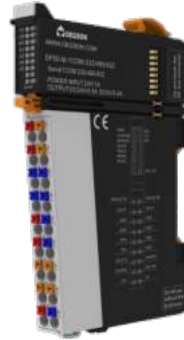

DF50-M-1COM-232/485/422

Serial communication module, 1 channel

Specification

Product	DF50-M-1COM-232/485/422
Interface	RS232/RS485/RS422
Number of channels	1
Agreement	Modbus RTU Free protocol transparent mode
BAUD	1200bps - 256000bps
Data bits	7bit / 8bit
Check bit	None / Even / Odd
Stop bit	1bit / 2bit
Maximum data frame length	64byte
Termination resistor	Built in 120 Ω terminal resistor
Firmware upgrade function	Support

Power Supply Parameters

Connection type	PUSH-IN type terminal block
System feed current	<100mA
Maximum area of wire	1.5mm ²
Maximum area of wire (AWG)	AWG16
The minimum area of a wire	0.14mm ²
The minimum area of a wire (AWG)	AWG26
Strip length	8...10mm

Mechanical Structure

Protection grade	IP20
Size(H X W X D)	111mm X 12mm X 75mm
Installation type	35mm DIN

Work Environment

Working temperature	-25...60°C
Storage temperature	-40...85°C
Relative humidity	5... 95%RH(non-condensing)

Serial communication module



Product DF50-M-1COM-232/485/422

LED Status Indicator

PW	Green: Internal bus power supply is normal
ST	Power on stage: green on: module initialization abnormal, green off: module initialization normal
	Operation phase: Green flashing: The internal bus of the module is working normally, green off: The internal bus of the module is working abnormally
COM	On: Input signal valid Off: Input signal invalid
MST	On: Input signal valid Off: Input signal invalid
SLV	On: Input signal valid Off: Input signal invalid
232	In 232 mode, on: connection normal off: connection abnormal
485	In 485 mode, on: connection normal off: connection abnormal
422	In 422 mode, on: connection normal off: connection abnormal
TS	Flashing: Normal communication transmission Off: Abnormal communication transmission
RX	Flashing: normal communication reception Off: abnormal communication reception
EP	On: External power supply normal Off: External power supply normal

Wiring Diagram

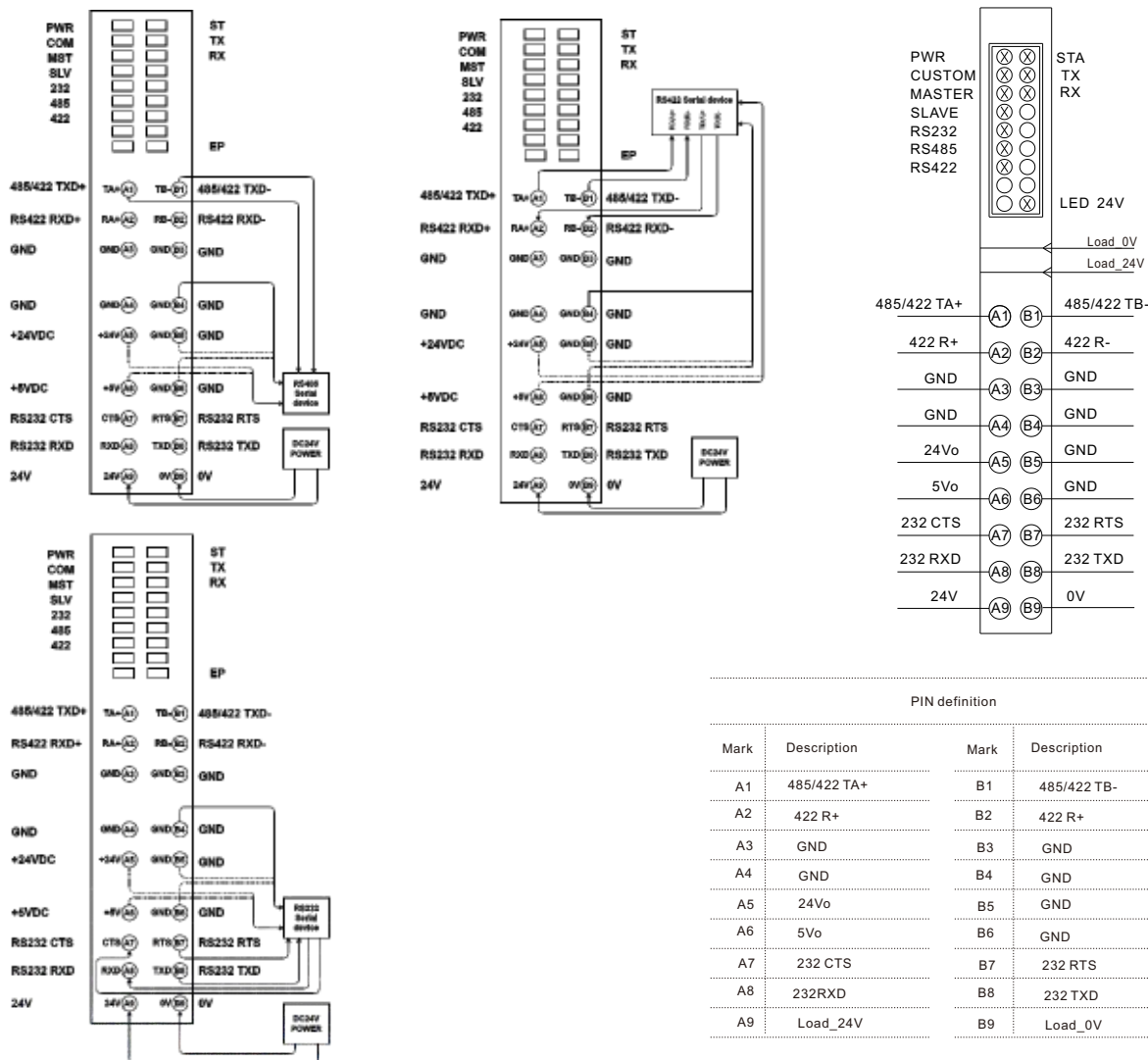

Voltage distribution module

RoHS

DF50-M-DC-U-0

Voltage distribution module, 16 channel 0VDC

Specification

Product	DF50-M-DC-U-0
Number of channels	16

Power Supply Parameters

Connection type	PUSH-IN type terminal block
System feed current	<100mA
Maximum area of wire	1.5mm ²
Maximum area of wire (AWG)	AWG16
The minimum area of a wire	0.14mm ²
The minimum area of a wire (AWG)	AWG26
Strip length	8...10mm

Voltage distribution module



RoHS

Product DF50-M-DC-U-0

Mechanical Structure

Protection grade IP20

Size(H X W X D) 111mm X 12mm X 75mm

Installation type 35mm DIN

Work Environment

Working temperature -25...60°C

Storage temperature -40...85°C

Relative humidity 5... 95%RH(non-condensing)

Wiring Diagram

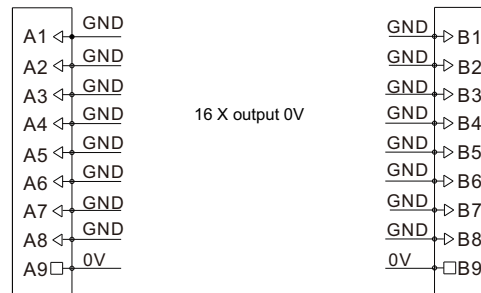
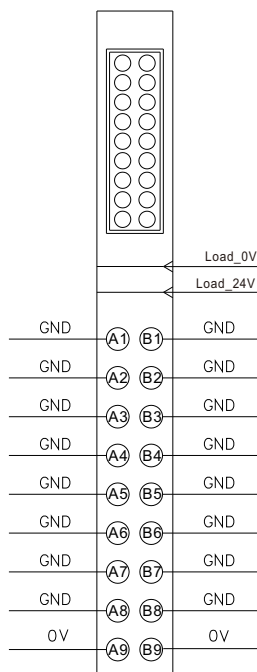

PIN definition

Mark	Description	Mark	Description
A1	output 0V	B1	output 0V
A2	output 0V	B2	output 0V
A3	output 0V	B3	output 0V
A4	output 0V	B4	output 0V
A5	output 0V	B5	output 0V
A6	output 0V	B6	output 0V
A7	output 0V	B7	output 0V
A8	output 0V	B8	output 0V
A9	input 0V	B9	input 0V

Voltage distribution module

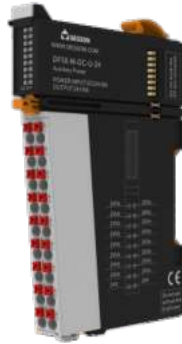
RoHS

DF50-M-DC-U-24

Voltage distribution module, 16 channel 24VDC

Specification

Product	DF50-M-DC-U-24
Number of channels	16

Power Supply Parameters

Connection type	PUSH-IN type terminal block
System feed current	<100mA
Maximum area of wire	1.5mm ²
Maximum area of wire (AWG)	AWG16
The minimum area of a wire	0.14mm ²
The minimum area of a wire (AWG)	AWG26
Strip length	8...10mm

Voltage distribution module



RoHS

Product	DF50-M-DC-U-24
---------	----------------

Mechanical Structure

Protection grade	IP20
Size(H X W X D)	111mm X 12mm X 75mm
Installation type	35mm DIN

Work Environment

Working temperature	-25...60°C
Storage temperature	-40...85°C
Relative humidity	5... 95%RH(non-condensing)

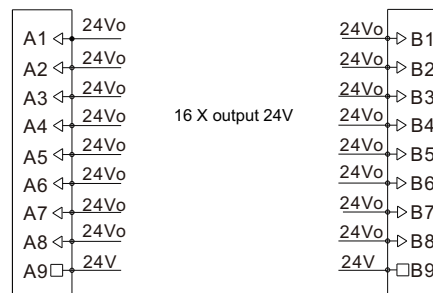
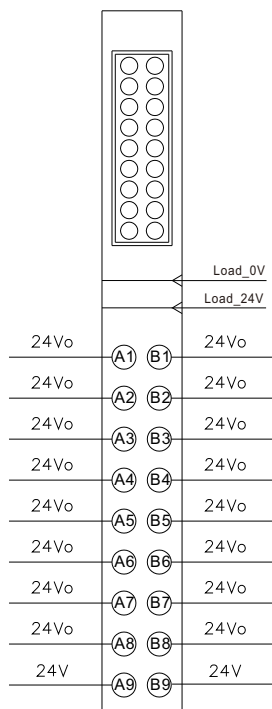
Wiring Diagram

PIN definition

Mark	Description	Mark	Description
A1	output 24V	B1	output 24V
A2	output 24V	B2	output 24V
A3	output 24V	B3	output 24V
A4	output 24V	B4	output 24V
A5	output 24V	B5	output 24V
A6	output 24V	B6	output 24V
A7	output 24V	B7	output 24V
A8	output 24V	B8	output 24V
A9	input 24V	B9	input 24V

DF50 series dimension

DF50 series bus coupler dimension

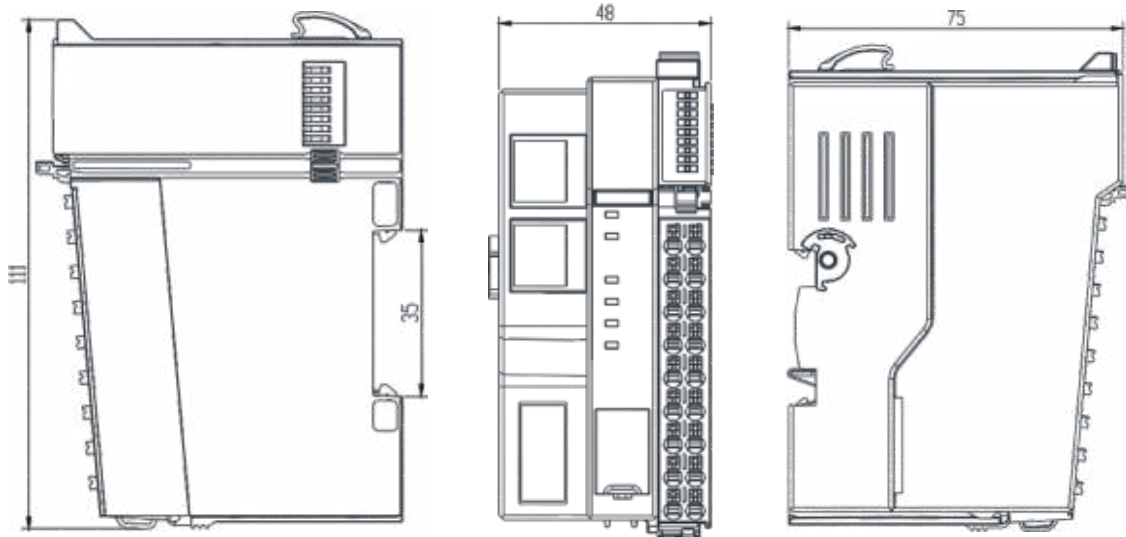

DF50 series I/O module & Terminal cover dimension

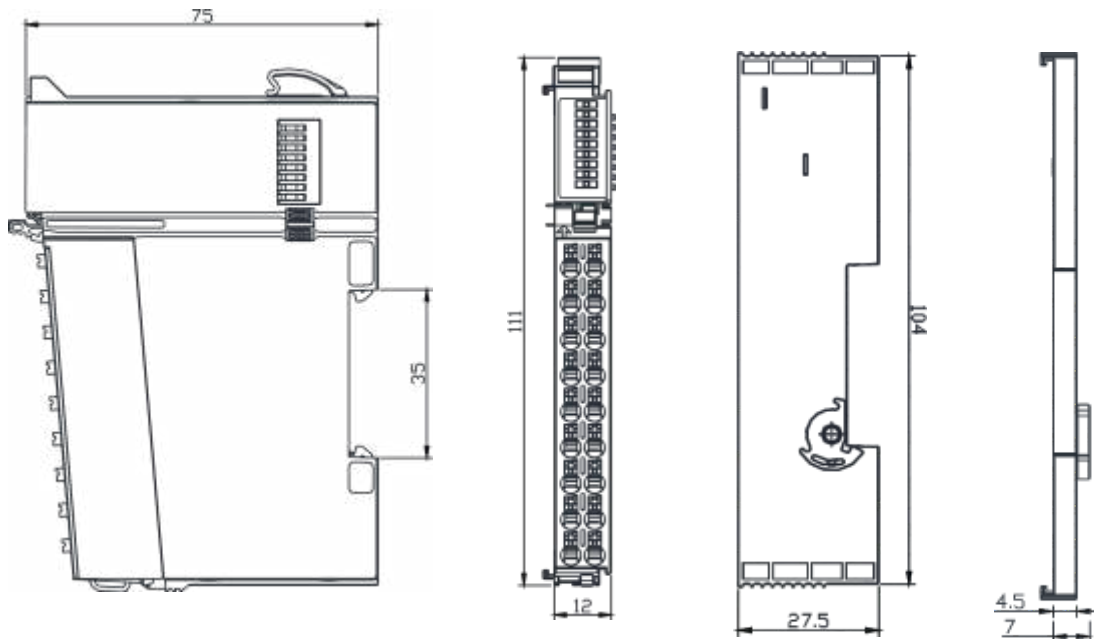

DF58 series I/O



Small



Compact



Convenient

- The DF58 series I/O system adopts 100M backplane bus for high-speed response to requirements
- Comprehensively improve I/O performance and compatibility
- Tool free use, greatly improving convenience
- The bus coupler supports 32 modules, and only when there are more than 16 extension modules, an additional power module is required

DF58 Series I/O Modules

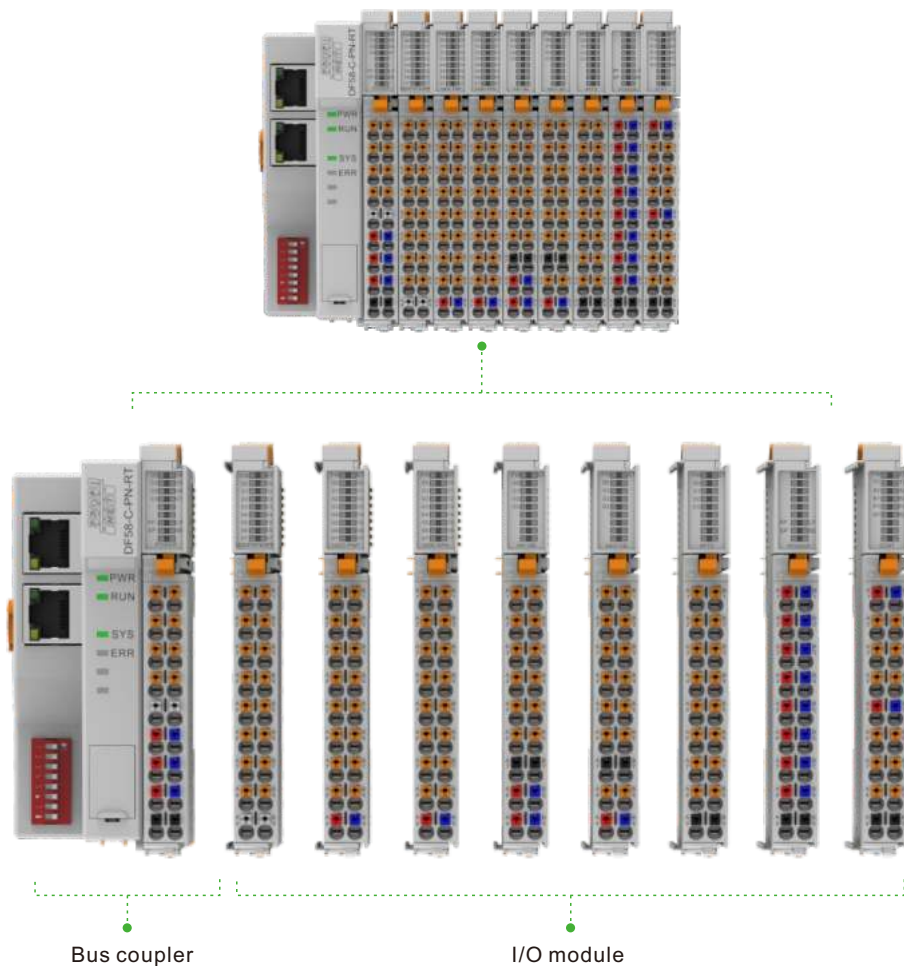

Bus coupler

- The bus coupler comes with 8 digital inputs
- Supports multiple industrial Ethernet bus protocols
- 100M high-speed backplane bus, supporting up to 32 modules
- 16 modules do not require additional power modules; 17-32 modules require an additional power module

Tool free

- No tools required for module installation and disassembly
- No tools required to install and remove front connectors
- No tools required for wiring and dismantling

I/O module

- Digital input compatible with both PNP and NPN signals
- The analog input/output module is compatible with current and voltage, supports multiple ranges and each channel can be independently selected, and supports 2, 3, and 4 wire connection methods

Appearance

- 12mm ultra-thin volume, sharp blade shape
- The module has an identification system
- The module is grounded through the back metal connection DIN-rail
- Distinguish wiring holes with different functions by color

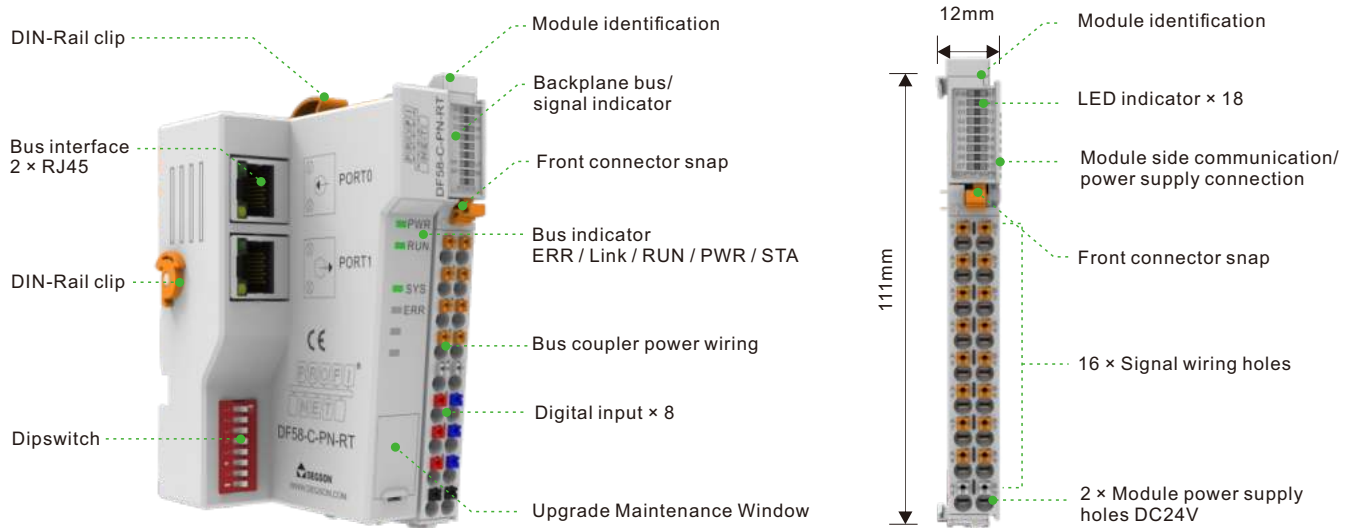

- PUSH-IN, no tools required for wire connection and disassembly



- Pluggable front connector

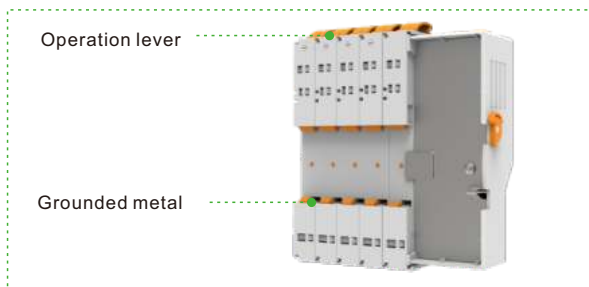

- Tool free manual operation lever
- The module is grounded through the back metal connection DIN-rail

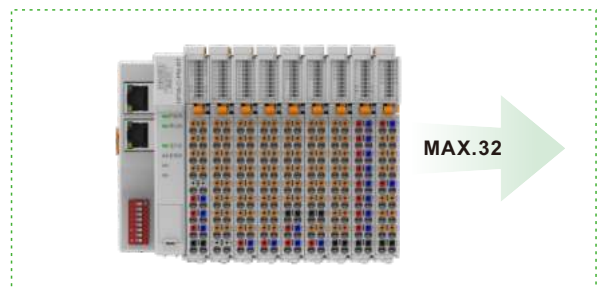

- Bus coupler can support up to 32 modules

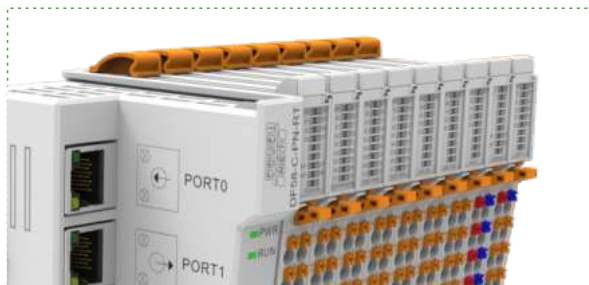

- Module has identification
- The module indicator system contains information such as signals, power, faults ...



- Communication between modules through side connecting finger
- Module power supply is connected through side metal clips

PROFINET Bus coupler



DF58-C-PN-RT

Features

- With a power module.
- LED display working status, alarm and bus fault prompt.
- Two PROFINET interface (RJ45, 10/100Mbps).
- With Media Redundancy Protocol.

PROFINET, 2 RJ45, extensible 32 modules, 24VDC

Specification		Digital Inputs Specification	
Product	DF58-C-PN-RT	Number of channels	8
Communication protocol	PROFINET	Data size	1 Byte
Transmission rate	100Mbps, full duplex	Signal type	NPN & PNP
Transmission distance	100 meters	"0" signal voltage	<5V
PDO data	512 bytes	"1" signal voltage	>15V
Number of extensible modules	32	Connection type	1-line
Address mapping	Yes	Reverse protection	Yes
Address setting	PROFINET specification	Isolation method	Photoelectric isolation
Transmission medium	Class 5 twisted pair cable	Fault diagnosis	Yes
Isolation method	Electrical isolation	Typical input current	0.678mA
Features	RT, conforming to Class C, MRP, automatic addressing/topology detection	Fault diagnosis	4.07mA
		Typical input current	2.46mA
Alarm function	Diagnostic alarm, process alarm, plug and unplug connector alarm	Fault diagnosis	4.7mA
		Filtering time	No filtering, 0.25ms, 0.5ms, 1ms (factory setting), 2ms, 4ms, 8ms, 16ms, 32ms
Minimum cycle time	1ms	Hardware response time	100us

Power Supply Parameters

Connection type	PUSH-IN type terminal block	The minimum area of a wire (AWG)	AWG26
Working voltage	24V DC +20 %/ -15 %	Strip length	8...10mm
Working current	0.35A ~ 6A	Supply system voltage	5VDC
Maximum area of wire	1.5mm ²	Supply system current	Max.2A
Maximum area of wire (AWG)	AWG16	Supply load voltage	24V...36VDC
The minimum area of a wire	0.14mm ²	Supply load current (MAX)	5A

PROFINET Bus coupler



Product DF58-C-PN-RT

Mechanical Structure

Protection grade IP20
 Size(H X W X D) 111mm X 48mm X 75mm
 Installation type 35mm DIN

Work Environment

Working temperature -25...60°C
 Storage temperature -40...85°C
 Relative humidity 5...95%RH(non-condensing)

LED Status Indicator

PWR	Green: Power is working
RUN	Green: I/O system is running
SYS	Blinking green: The module is working
ERR	Red: An error occurred between I/O system and module
LED Sys 24v	Green: The system power is working(24V)
LED Load 24V	Green: The load power is working
LED Sys 5V	Green: The system power is working(5V)

Wiring Diagram

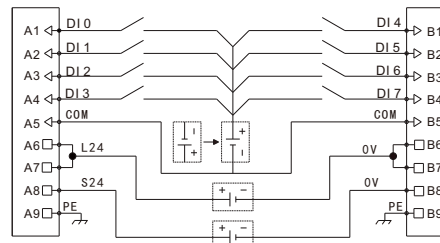
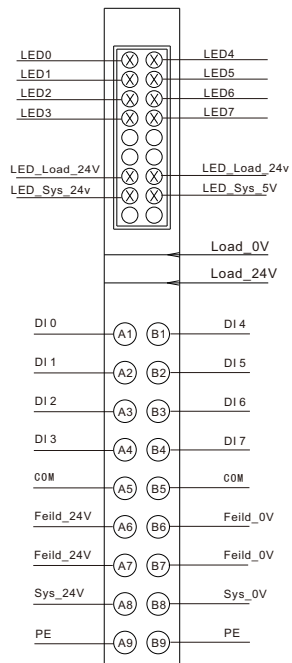

PIN definition

Mark	Description	Mark	Description
A1	input 0	B1	input 4
A2	input 1	B2	input 5
A3	input 2	B3	input 6
A4	input 3	B4	input 7
A5	COM	B5	COM
A6	Feild_24V	B6	Feild_0V
A7	Feild_24V	B7	Feild_0V
A8	Sys_24V	B8	Sys_0V
A9	PE	B9	PE

COM is the common terminal of DI0~DI7, connected To 24V is NPN, and connected to 0V is PNP



DF58-C-EC

EtherCAT, 2 RJ45, extensible 32 modules, 24VDC

Features

- With a power module.
- LED display working status, alarm and bus fault prompt.
- Two EtherCAT interface (RJ45, 100Mbps).

Specification		Digital Inputs Specification	
Product	DF58-C-EC	Number of channels	8
Communication protocol	EtherCAT	Data size	1 Byte
Transmission rate	100Mbps, full duplex	Signal type	NPN & PNP
Transmission distance	100 meters	"0" signal voltage	<5V
PDO data	1024 bytes	"1" signal voltage	>15V
Number of extensible modules	32	Connection type	1-line
Address mapping	Yes	Reverse protection	Yes
Address setting	EtherCAT specification, DIP switch	Isolation method	Photoelectric isolation
Transmission medium	Class 5 twisted pair cable	Fault diagnosis	Yes
Isolation method	Electrical isolation	Typical input current	0.678mA
Alias range	1~254	Fault diagnosis	4.07mA
Alarm function	Diagnostic alarm, process alarm, plug and unplug connector alarm	Typical input current	2.46mA
Connection type	2 X RJ45, with switch function	Fault diagnosis	4.7mA
		Filtering time	No filtering, 0.25ms, 0.5ms, 1ms (factory setting), 2ms, 4ms, 8ms, 16ms, 32ms
		Hardware response time	100us

Power Supply Parameters

Connection type	PUSH-IN type terminal block	The minimum area of a wire (AWG)	AWG26
Working voltage	24V DC +20 %/ -15 %	Strip length	8...10mm
Working current	0.35A ~ 6A	Supply system voltage	5VDC
Maximum area of wire	1.5mm ²	Supply system current	Max.2A
Maximum area of wire (AWG)	AWG16	Supply load voltage	24V...36VDC
The minimum area of a wire	0.14mm ²	Supply load current (MAX)	5A

EtherCAT Bus coupler



Product DF58-C-EC

Mechanical Structure

Protection grade IP20
 Size(H X W X D) 111mm X 48mm X 75mm
 Installation type 35mm DIN

Work Environment

Working temperature -25...60°C
 Storage temperature -40...85°C
 Relative humidity 5...95%RH(non-condensing)

LED Status Indicator

PWR	Green: Power is working
RUN	Green: I/O system is running
SYS	Blinking green: The module is working
ERR	Red: An error occurred between I/O system and module
LED Sys 24v	Green: The system power is working(24V)
LED Load 24V	Green: The load power is working
LED Sys 5V	Green: The system power is working(5V)

Wiring Diagram

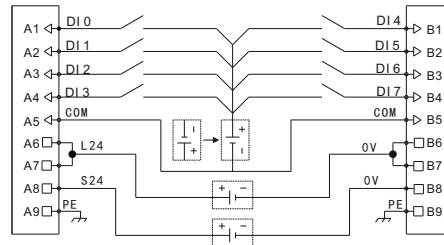
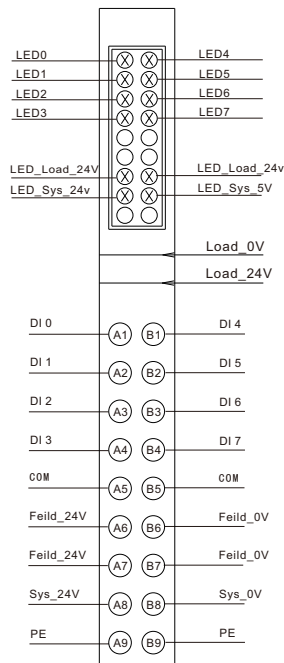

PIN definition

Mark	Description	Mark	Description
A1	input 0	B1	input 4
A2	input 1	B2	input 5
A3	input 2	B3	input 6
A4	input 3	B4	input 7
A5	COM	B5	COM
A6	Feild_24V	B6	Feild_0V
A7	Feild_24V	B7	Feild_0V
A8	Sys_24V	B8	Sys_0V
A9	PE	B9	PE

COM is the common terminal of DI0~DI7, connected To 24V is NPN, and connected to 0V is PNP

CC-LINK IE Field Basic Bus coupler



DF58-C-CC-FB

Features

- With a power module.
- LED display working status, alarm and bus fault prompt.
- CC-LINK IE Field Basic interface (RJ45, 10/100Mbps).

CC-LINK IE Field Basic, 2 RJ45, extensible 32 modules, 24VDC

Specification		Digital Inputs Specification	
Product	DF58-C-CC-FB	Number of channels	8
Communication protocol	CC-LINK IE Field Basic	Data size	1 Byte
Transmission rate	100Mbps, full duplex	Signal type	NPN & PNP
Transmission distance	100 meters	"0" signal voltage	<5V
PDO data	576 bytes	"1" signal voltage	>15V
Number of extensible modules	32	Connection type	1-line
Address mapping	Yes	Reverse protection	Yes
Address setting	CC-LINK IE Field Basic specification, DIP switch	Isolation method	Photoelectric isolation
Transmission medium	Class 5 twisted pair cable	Fault diagnosis	Yes
Isolation method	Electrical isolation	Typical input current	0.678mA
Address range	1~254	Fault diagnosis	4.07mA
		Typical input current	2.46mA
Alarm function	Diagnostic alarm, process alarm, plug and unplug connector alarm	Fault diagnosis	4.7mA
		Filtering time	No filtering, 0.25ms, 0.5ms, 1ms (factory setting), 2ms, 4ms, 8ms, 16ms, 32ms
Connection type	2 X RJ45, with switch function	Hardware response time	100us

Power Supply Parameters

Connection type	PUSH-IN type terminal block	The minimum area of a wire (AWG)	AWG26
Working voltage	24V DC +20 % / -15 %	Strip length	8...10mm
Working current	0.35A ~ 6A	Supply system voltage	5VDC
Maximum area of wire	1.5mm ²	Supply system current	Max.2A
Maximum area of wire (AWG)	AWG16	Supply load voltage	24V...36VDC
The minimum area of a wire	0.14mm ²	Supply load current (MAX)	5A

CC-LINK IE Field Basic Bus coupler



Product	DF58-C-CC-FB
Mechanical Structure	
Protection grade	IP20
Size(H X W X D)	111mm X 48mm X 75mm
Installation type	35mm DIN
Work Environment	
Working temperature	-25...60°C
Storage temperature	-40...85°C
Relative humidity	5...95%RH(non-condensing)
LED Status Indicator	
PWR	Green: Power is working
RUN	Green: I/O system is running
SYS	Blinking green: The module is working
ERR	Red: An error occurred between I/O system and module
LED Sys 24v	Green:The system power is working(24V)
LED Load 24V	Green: The load power is working
LED Sys 5V	Green:The system power is working(5V)
Wiring Diagram	

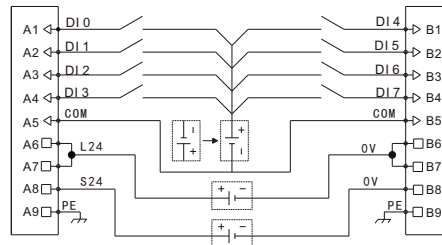
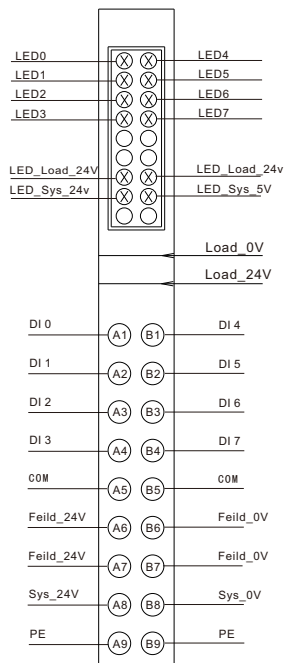

PIN definition

Mark	Description	Mark	Description
A1	input 0	B1	input 4
A2	input 1	B2	input 5
A3	input 2	B3	input 6
A4	input 3	B4	input 7
A5	COM	B5	COM
A6	Feild_24V	B6	Feild_0V
A7	Feild_24V	B7	Feild_0V
A8	Sys_24V	B8	Sys_0V
A9	PE	B9	PE

COM is the common terminal of DI0~DI7, connected To 24V is NPN, and connected to 0V is PNP

Modbus TCP/IP Bus coupler



DF58-C-MD-TCP

Features

- With a power module.
- LED display working status, alarm and bus fault prompt.
- Modbus TCP/IP interface (RJ45, 10/100Mbps)

Modbus TCP/IP, 1 RJ45, extensible 16 modules, 24VDC

Specification		Digital Inputs Specification	
Product	DF58-C-MD-TCP	Number of channels	8
Communication protocol	Modbus TCP/IP	Data size	1 Byte
Transmission rate	100Mbps, full duplex	Signal type	NPN & PNP
Transmission distance	100 meters	"0" signal voltage	<5V
PDO data	1024 bytes	"1" signal voltage	>15V
Number of extensible modules	32	Connection type	1-line
Address mapping	Yes	Reverse protection	Yes
Address setting	Modbus TCP/IP specification, DIP switch	Isolation method	Photoelectric isolation
Transmission medium	Class 5 twisted pair cable	Fault diagnosis	Yes
Isolation method	Electrical isolation	Typical input current	0.678mA
Address range	1~254	Fault diagnosis	4.07mA
		Typical input current	2.46mA
Alarm function	Diagnostic alarm, process alarm, plug and unplug connector alarm	Fault diagnosis	4.7mA
		Filtering time	No filtering, 0.25ms, 0.5ms, 1ms (factory setting), 2ms, 4ms, 8ms, 16ms, 32ms
Support Modbus function	02,03,05,06,15,16	Hardware response time	100us

Power Supply Parameters

Connection type	PUSH-IN type terminal block	The minimum area of a wire (AWG)	AWG26
Working voltage	24V DC +20 % / -15 %	Strip length	8...10mm
Working current	0.35A ~ 6A	Supply system voltage	5VDC
Maximum area of wire	1.5mm ²	Supply system current	Max.2A
Maximum area of wire (AWG)	AWG16	Supply load voltage	24V...36VDC
The minimum area of a wire	0.14mm ²	Supply load current (MAX)	5A

Modbus TCP/IP Bus coupler



Product	DF58-C-MD-TCP
Mechanical Structure	
Protection grade	IP20
Size(H X W X D)	111mm X 48mm X 75mm
Installation type	35mm DIN
Work Environment	
Working temperature	-25...60°C
Storage temperature	-40...85°C
Relative humidity	5...95%RH(non-condensing)
LED Status Indicator	
PWR	Green: Power is working
RUN	Green: I/O system is running
SYS	Blinking green: The module is working
ERR	Red: An error occurred between I/O system and module
LED Sys 24v	Green:The system power is working(24V)
LED Load 24V	Green: The load power is working
LED Sys 5V	Green:The system power is working(5V)
Wiring Diagram	

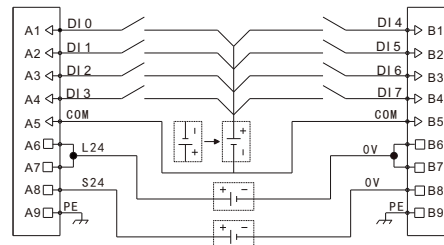
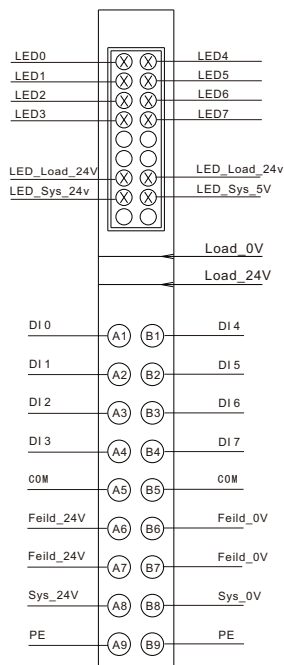

PIN definition

Mark	Description	Mark	Description
A1	input 0	B1	input 4
A2	input 1	B2	input 5
A3	input 2	B3	input 6
A4	input 3	B4	input 7
A5	COM	B5	COM
A6	Feild_24V	B6	Feild_0V
A7	Feild_24V	B7	Feild_0V
A8	Sys_24V	B8	Sys_0V
A9	PE	B9	PE

COM is the common terminal of DI0~DI7, connected To 24V is NPN, and connected to 0V is PNP

EtherNet/IP Bus coupler





DF58-C-EN-IP

EtherNet/IP, 2 RJ45, extensible 32 modules, 24VDC

Features

- With a power module.
- LED display working status, alarm and bus fault prompt.
- Two EtherNet/IP interface (RJ45, 10/100Mbps).

Specification		Digital Inputs Specification	
Product	DF58-C-EN-IP	Number of channels	8
Communication protocol	EtherNet/IP	Data size	1 Byte
Transmission rate	100Mbps, full duplex	Signal type	NPN & PNP
Transmission distance	100 meters	"0" signal voltage	<5V
PDO data	1024 bytes	"1" signal voltage	>15V
Number of extensible modules	32	Connection type	1-line
Address mapping	Yes	Reverse protection	Yes
Address setting	EtherNet/IP specification, DIP switch	Isolation method	Photoelectric isolation
Transmission medium	Class 5 twisted pair cable	Fault diagnosis	Yes
Isolation method	Electrical isolation	Typical input current	0.678mA
		Fault diagnosis	4.07mA
Minimum cycle time	1ms	Typical input current	2.46mA
		Fault diagnosis	4.7mA
Alarm function	Diagnostic alarm, process alarm, plug and unplug connector alarm	Filtering time	No filtering, 0.25ms, 0.5ms, 1ms (factory setting), 2ms, 4ms, 8ms, 16ms, 32ms
		Hardware response time	100us

Power Supply Parameters

Connection type	PUSH-IN type terminal block	The minimum area of a wire (AWG)	AWG26
Working voltage	24V DC +20 % / -15 %	Strip length	8...10mm
Working current	0.35A ~ 6A	Supply system voltage	5VDC
Maximum area of wire	1.5mm ²	Supply system current	Max.2A
Maximum area of wire (AWG)	AWG16	Supply load voltage	24V...36VDC
The minimum area of a wire	0.14mm ²	Supply load current (MAX)	5A

EtherNet/IP Bus coupler



Product DF58-C-EN-IP

Mechanical Structure

Protection grade IP20
 Size(H X W X D) 111mm X 48mm X 75mm
 Installation type 35mm DIN

Work Environment

Working temperature -25...60°C
 Storage temperature -40...85°C
 Relative humidity 5...95%RH(non-condensing)

LED Status Indicator

PWR	Green: Power is working
RUN	Green: I/O system is running
SYS	Blinking green: The module is working
ERR	Red: An error occurred between I/O system and module
LED Sys 24v	Green:The system power is working(24V)
LED Load 24V	Green: The load power is working
LED Sys 5V	Green:The system power is working(5V)

Wiring Diagram

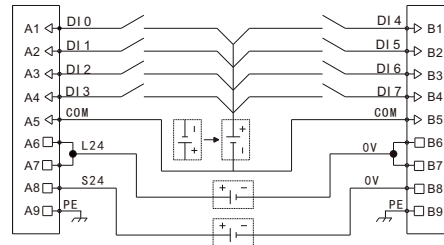
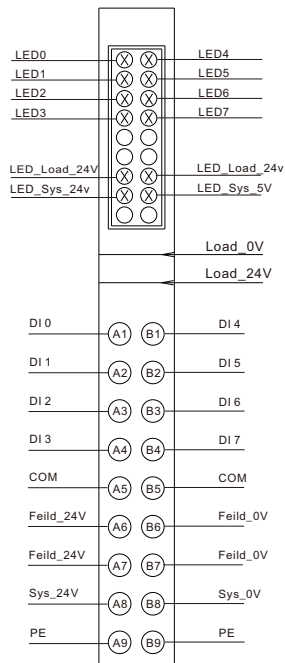

PIN definition

Mark	Description	Mark	Description
A1	input 0	B1	input 4
A2	input 1	B2	input 5
A3	input 2	B3	input 6
A4	input 3	B4	input 7
A5	COM	B5	COM
A6	Feild_24V	B6	Feild_0V
A7	Feild_24V	B7	Feild_0V
A8	Sys_24V	B8	Sys_0V
A9	PE	B9	PE

COM is the common terminal of DI0~DI7, connected To 24V is NPN, and connected to 0V is PNP

DF58-M-16DI-P/N

Digital input module, 16 ports, PNP/NPN,24VDC

Specification

Product	DF58-M-16DI-P/N
Number of channels	16
Data size	2 Byte
Signal type	NPN & PNP
"0" signal voltage	<5V
"1" signal voltage	>15V
Connection type	1-line
Reverse protection	Yes
Isolation method	Photoelectric isolation
Fault diagnosis	Yes
Typical input current	0.678mA
Fault diagnosis	4.07mA
Typical input current	2.46mA
Fault diagnosis	4.7mA
Filtering time	No filtering, 0.25ms, 0.5ms, 1ms (factory setting), 2ms, 4ms, 8ms, 16ms, 32ms,
Hardware response time	100us

Power Supply Parameters

Connection type	PUSH-IN type terminal block
Working voltage	24V DC +20 %/ -15 %
System feed current	<15mA
Maximum area of wire	1.5mm ²
Maximum area of wire (AWG)	AWG16
The minimum area of a wire	0.14mm ²
The minimum area of a wire (AWG)	AWG26
Strip length	8...10mm

Digital input module



Product	DF58-M-16DI-P/N
Mechanical Structure	
Protection grade	IP20
Size(H X W X D)	111mm X 12mm X 75mm
Installation type	35mm DIN
Work Environment	
Working temperature	-25...60°C
Storage temperature	-40...85°C
Relative humidity	5...95%RH(non-condensing)
LED Status Indicator	
PW	Green: Power is working
ST	Green: I/O system and modules working properly.
LED	On: input signal is valid
Wiring Diagram	

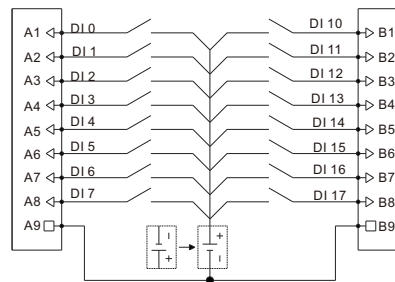
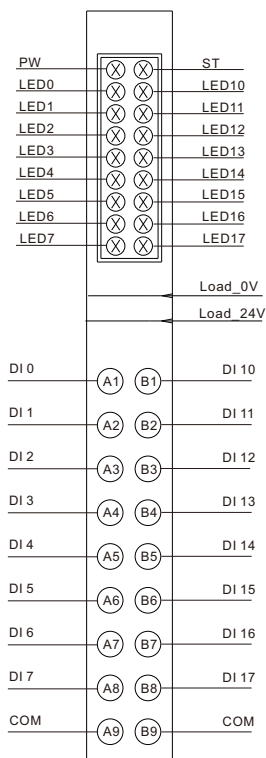

PIN definition

Mark	Description	Mark	Description
A1	input 0	B1	input 10
A2	input 1	B2	input 11
A3	input 2	B3	input 12
A4	input 3	B4	input 13
A5	input 4	B5	input 14
A6	input 5	B6	input 15
A7	input 6	B7	input 16
A8	input 7	B8	input 17
A9	COM	B9	COM

COM is the common terminal of DI0~DI17, connected To 24V is NPN, and connected to 0V is PNP

Digital output module

DF58-M-16DO-N

Digital output module, 16 ports, NPN, 24VDC

DF58-M-16DO-P

Digital output module, 16 ports, PNP, 24VDC

Specification

Product	DF58-M-16DO-N	DF58-M-16DO-P
Number of channels	16	
Data size	2 Byte	
Signal type	NPN	PNP
"0" signal voltage	high-impedance state	high-impedance state
"1" signal voltage	0V DC	24V DC
Connection type	1-line	
Reverse protection	Yes	
Isolation method	Photoelectric isolation	
Switching Frequency (resistance/lamp load)	<1000Hz	
Switching Frequency (Inductive load)	<0.2Hz	
Response Time of the Protection Circuit	< 100µs	
Output current per channel(MAX)	500 mA	
Load type	Inductance, resistance, lamp	

Power Supply Parameters

Connection type	PUSH-IN type terminal block
Working voltage	24V DC +20 %/ -15 %
System feed current	<75mA
Maximum area of wire	1.5mm ²
Maximum area of wire (AWG)	AWG16
The minimum area of a wire	0.14mm ²
The minimum area of a wire (AWG)	AWG26
Strip length	8...10mm

Digital output module



Product	DF58-M-16DO-N	DF58-M-16DO-P
---------	---------------	---------------

Mechanical Structure

Protection grade	IP20
Size(H X W X D)	111mm X 12mm X 75mm
Installation type	35mm DIN

Work Environment

Working temperature	-25...60°C
Storage temperature	-40...85°C
Relative humidity	5...95%RH(non-condensing)

LED Status Indicator

PW	Green: Power is working
ST	Green: I/O system and modules working properly.
LED	On: input signal is valid

Wiring Diagram

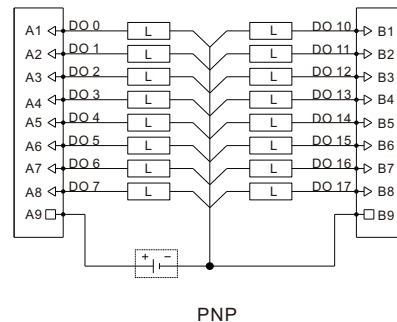
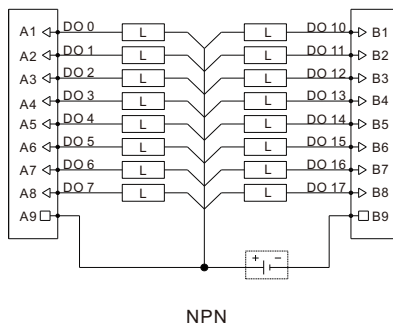
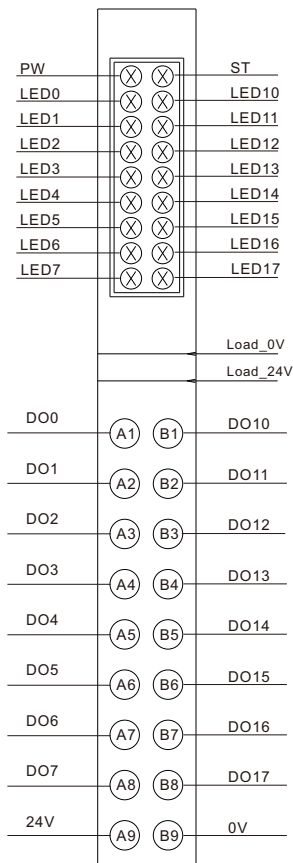

PIN definition

Mark	Description	Mark	Description
A1	output 0	B1	output 10
A2	output 1	B2	output 11
A3	output 2	B3	output 12
A4	output 3	B4	output 13
A5	output 4	B5	output 14
A6	output 5	B6	output 15
A7	output 6	B7	output 16
A8	output 7	B8	output 17
A9	24V	B9	0V

DF58-M-4AI-UI-6

Analog input module, 4 channels, voltage type, current type

Specification

Product	DF58-M-4AI-UI-6
Number of channels	4
Data size	8 Byte
Voltage test range	$\pm 10V$, 0-10V, 2-10V, $\pm 5V$, 0-5V, 1-5V
Current test range	$\pm 20mA$, 0-20mA, 4-20mA
Connection type	2/3/4-line
Reverse protection	Yes
Isolation method	Magnetic isolation
Fault diagnosis	Yes
Internal Resistance	$>450K\Omega$
Resolution	16 Bit
Signal type	difference
Conversion digital quantity range configuration	Default configuration (- 27648 to 27648), support ± 32000
Precision	0.20%
Conversion time	400us/channel
Sampling rate	20-300Hz (Configuration)

Power Supply Parameters

Connection type	PUSH-IN type terminal block
Working voltage	24V DC +20 %/ -15 %
System feed current	$<120mA$
Maximum area of wire	1.5mm ²
Maximum area of wire (AWG)	AWG16
The minimum area of a wire	0.14mm ²
The minimum area of a wire (AWG)	AWG26
Strip length	8...10mm

Analog input module



Product	DF58-M-4AI-UI-6
---------	-----------------

Mechanical Structure

Protection grade	IP20
Size(H X W X D)	111mm X 12mm X 75mm
Installation type	35mm DIN

Work Environment

Working temperature	-25...60°C
Storage temperature	-40...85°C
Relative humidity	5...95%RH(non-condensing)

LED Status Indicator

LED0	Green: Signal on Channel 1.
LED1	Green: Signal on Channel 2.
LED2	Green: Signal on Channel 3.
LED3	Green: Signal on Channel 4.
PW	Green: Power is working.
ST	Green: I/O system and modules working properly.

Wiring Diagram

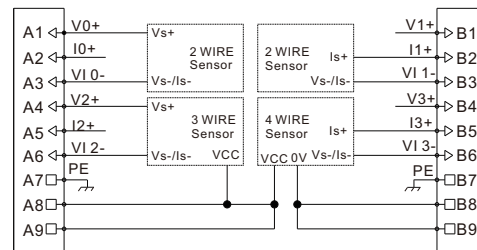
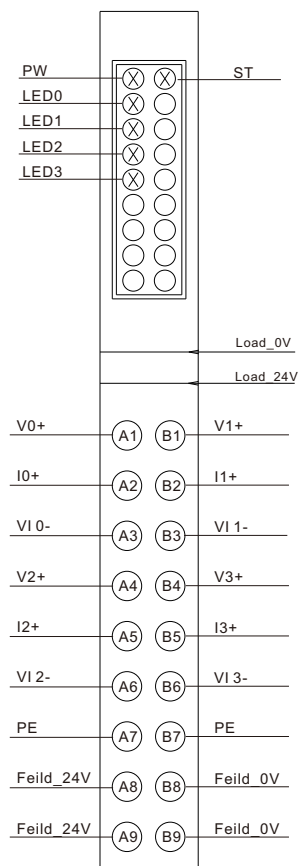

PIN definition

Mark	Description	Mark	Description
A1	Voltage input 0+	B1	Voltage input 1+
A2	Current input 0+	B2	Current input 1+
A3	Voltage/Current input 0-	B3	Voltage/Current input 1-
A4	Voltage input 2+	B4	Voltage input 3+
A5	Current input 2+	B5	Current input 3+
A6	Voltage/Current input 2-	B6	Voltage/Current input 3-
A7	PE	B7	PE
A8	Load_24V	B8	Load_0V
A9	Load_24V	B9	Load_0V

Analog output module



RoHS

DF58-M-4AO-UI-6

Analog output module, 4 channels, voltage type, current type

Specification

Product	DF58-M-4AO-UI-6
Number of channels	4
Data size	8 Byte
Voltage output range	$\pm 10V$, 0-10V, 2-10V, $\pm 5V$, 0-5V, 1-5V
Current output range	$\pm 20mA$, 0-20mA, 4-20mA
Signal type	Differential signal
Connection type	2/3/4-line
Overcurrent protection	Yes
Isolation method	Magnetic isolation
Fault diagnosis	Yes
Resolution	16 Bit
Precision	0.10%
Load type	Sensibility, resistance, tolerance
Conversion digital quantity range configuration	Default configuration (- 27684 to 27684), support ± 32000
Conversiontime	150us/channel

Power Supply Parameters

Connection type	PUSH-IN type terminal block
Working voltage	24V DC +20 %/ -15 %
System feed current	<110mA
Maximum area of wire	1.5mm ²
Maximum area of wire (AWG)	AWG16
The minimum area of a wire	0.14mm ²
The minimum area of a wire (AWG)	AWG26
Strip length	8...10mm

Analog output module



Product	DF58-M-4AO-UI-6
---------	-----------------

Mechanical Structure

Protection grade	IP20
Size(H X W X D)	111mm X 12mm X 75mm
Installation type	35mm DIN

Work Environment

Working temperature	-25...60°C
Storage temperature	-40...85°C
Relative humidity	5... 95%RH(non-condensing)

LED Status Indicator

PW	Green : Power is working
ST	Green blinks : I/O system and modules working properly
LED	Green: Signal on Channel 2.

Wiring Diagram

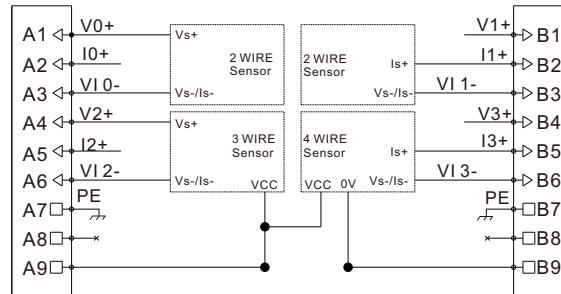
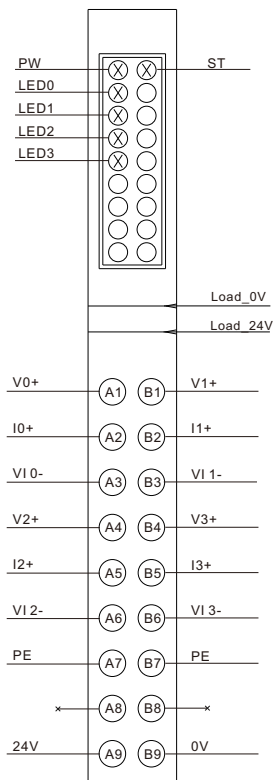

PIN definition

Mark	Description	Mark	Description
A1	Voltage output 0+	B1	Voltage output 1+
A2	Current output 0+	B2	Current output 1+
A3	Voltage/Current output 0-	B3	Voltage/Current output 1-
A4	Voltage output 2+	B4	Voltage output 3+
A5	Current output 2+	B5	Current output 3+
A6	Voltage/Current output 2-	B6	Voltage/Current output 3-
A7	PE	B7	PE
A8	/	B8	/
A9	Internal load_24V	B9	Internal load_0V

DF58-M-4RTD-PT

 Thermal Resistance (RTD) measurement module,
 16 bit resolution, 4 channels

Specification	
Product	DF58-M-4RTD-PT
Number of channels	4
Data size	8 Byte
Signal type	Thermal resistance
Signal type	Pt100, Pt200, Pt500, Pt1000, Ni100, Ni120, Ni 200, Ni500, Ni1000, Cu10, 40 Ω, 80 Ω, 150 Ω, 300 Ω, 500 Ω, 1 kΩ, 2 kΩ, 4 kΩ
Connection type	2/3/4-line
Reverse protection	Yes
Isolation method	Magnetic isolation between each channel and the field layer, and isolation between channels
Fault diagnosis	Yes
Resolution	16bit, 0.1°C/ each number
Frequency interference suppression	10Hz 50Hz 60Hz 400Hz
Diagnosis	Disconnection, Parameter assignment error
Process alarm	Upper/Lower limit, per channel
Temperature coefficient	±50ppm/K max.
Internal resistance	>500Ω
Precision	'max. 0.2 % FSR / 0.3 % FSR for Ni sensors / 0.6 % FSR for Cu10
Conversion time	100ms/4 channels

Temperature module



Product DF58-M-4RTD-PT

Power Supply Parameters

Connection type	PUSH-IN type terminal block
Working voltage	24V DC +20 %/ -15 %
System feed current	<100mA
Maximum area of wire	1.5mm ²
Maximum area of wire (AWG)	AWG16
The minimum area of a wire	0.14mm ²
The minimum area of a wire (AWG)	AWG26
Strip length	8...10mm

Mechanical Structure

Protection grade	IP20
Size(H X W X D)	111mm X 12mm X 75mm
Installation type	35mm DIN

Work Environment

Working temperature	-25...60°C
Storage temperature	-40...85°C
Relative humidity	5... 95%RH(non-condensing)

LED Status Indicator

PW	Green : Power is working
ST	Green blinks : I/O system and modules working properly
LED	On: input signal is valid

Wiring Diagram

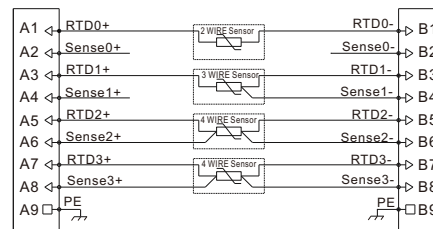
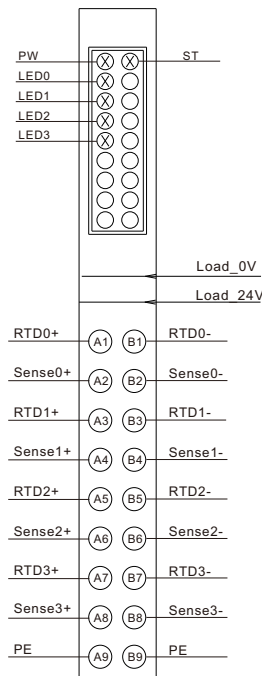

PIN definition

Mark	Description	Mark	Description
A1	RTD0+	B1	RTD0-
A2	Sense0+	B2	Sense0-
A3	RTD1+	B3	RTD1-
A4	Sense1+	B4	Sense1-
A5	RTD2+	B5	RTD2-
A6	Sense2+	B6	Sense2-
A7	RTD3+	B7	RTD3-
A8	Sense3+	B8	Sense3-
A9	PE	B9	PE

DF58-M-2CNT-PIL-24

24V Pulse counting module, 2 port, 24V

Specification

Product	DF58-M-2CNT-PIL-24
Maximum frequency count	1Mhz
Number of channels	2
Data size	20 Byte
Input signal type	Incremental encoder AB or pulse/direction signal
Input signal type	24V DC
Input connection type	2-Line / 4-Line
Filtering time	0.01 to 1 ms
Reverse protection	Yes
Isolation method	Isolate from the field layer optocoupler
Fault diagnosis	Yes, us response, error code can be queried by upper computer
Resolution	32 Bit
Precision	± 1 pulse

Power Supply Parameters

Connection type	PUSH-IN type terminal block
System feed current	<100mA
Maximum area of wire	1.5mm ²
Maximum area of wire (AWG)	AWG16
The minimum area of a wire	0.14mm ²
The minimum area of a wire (AWG)	AWG26
Strip length	8...10mm

Pulse counting module



Product	DF58-M-2CNT-PIL-24
Mechanical Structure	
Protection grade	IP20
Size(H X W X D)	111mm X 12mm X 66.8mm
Installation type	35mm DIN
Work Environment	
Working temperature	-25...60°C
Storage temperature	-40...85°C
Relative humidity	5...95%RH(non-condensing)
LED Status Indicator	
PW	Green : Power is working
ST	Green blinks : I/O system and modules working properly
TP	The signal is effective on and invalid off
A	On: A encoder input signal is valid
B	On: B encoder input signal is valid
UP	On: A encoder rotates in forward direction, off: encoder is stationary or rotates in reverse direction
DN	On: B encoder rotates in forward direction, off: encoder is stationary or rotates in reverse direction

Wiring Diagram

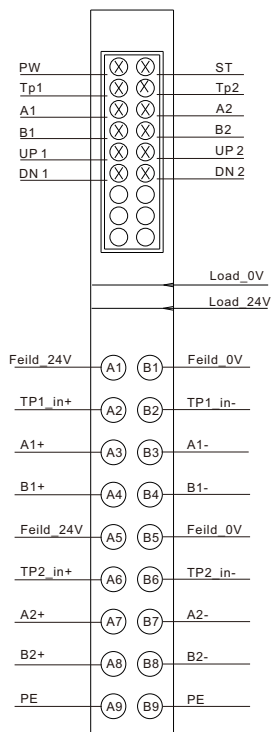

NPN, TP1_in+ — Load_24V, TP1_in- — Signal
 PNP, TP1_in+ — Signal, TP1_in- — Load_0V

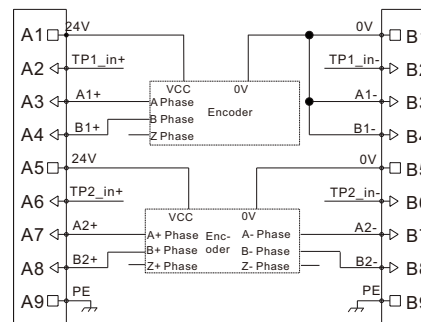

PIN definition

Mark	Description	Mark	Description
A1	Load_24V	B1	Load_0V
A2	TP1_in+ signal	B2	TP1_in- signal
A3	A1+ Phase	B3	A1- Phase
A4	B1+ Phase	B4	B1- Phase
A5	Load_24V	B5	Load_0V
A6	TP2_in+ signal	B6	TP2_in- signal
A7	A2+ Phase	B7	A2- Phase
A8	B2+ Phase	B8	B2- Phase
A9	PE	B9	PE

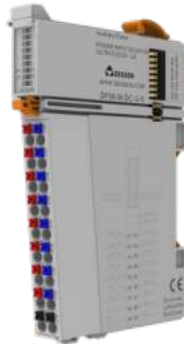
DF58-M-DC-U-5

System power supply module, 24VDC to 5VDC

Specification

Product	DF58-M-DC-U-5
Number of channels	1
Isolation method	System power supply to site power supply: isolation module

Power Supply Parameters

Connection type	PUSH-IN type terminal block
Working voltage	24V DC +20% / -15%
Reverse power protection	YES
Supply system voltage	5VDC
Supply system current	Max.2A@5V
Supply load voltage	24V DC +20% / -15%
Supply load current (MAX)	10A
Maximum area of wire	1.5mm ²
Maximum area of wire (AWG)	AWG16
The minimum area of a wire	0.14mm ²
The minimum area of a wire (AWG)	AWG26
Strip length	8...10mm

System power supply module

Product	DF58-M-DC-U-5
Mechanical Structure	
Protection grade	IP20
Size(H X W X D)	111mm X 12mm X 75mm
Installation type	35mm DIN
Work Environment	
Working temperature	-25...60°C
Storage temperature	-40...85°C
Relative humidity	5... 95%RH(non-condensing)
LED Status Indicator	
LED Sys 24v	Green:The system power is working(24V)
LED Load 24V	Green: The load power is working
LED Sys 5v	Green:The system power is working(5V)

Wiring Diagram

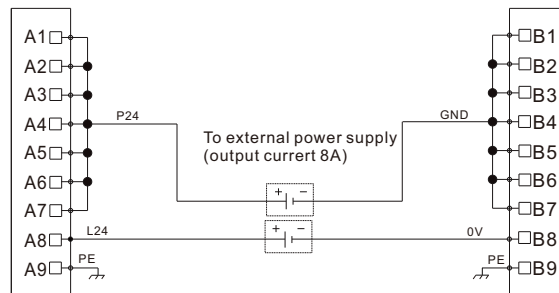
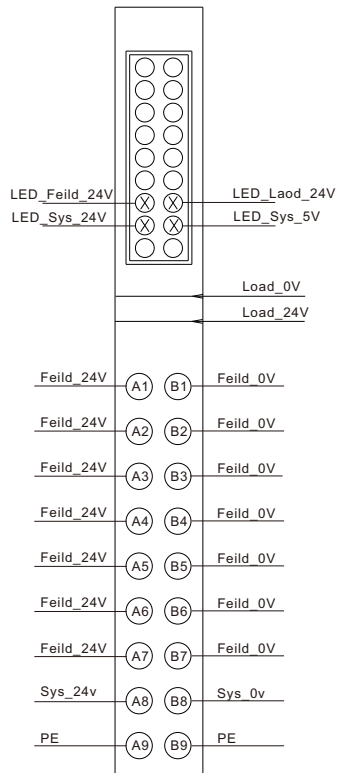

PIN definition

Mark	Description	Mark	Description
A1	Load_24V	B1	Load_0V
A2	Load_24V	B2	Load_0V
A3	Load_24V	B3	Load_0V
A4	Load_24V	B4	Load_0V
A5	Load_24V	B5	Load_0V
A6	Load_24V	B6	Load_0V
A7	Load_24V	B7	Load_0V
A8	Sys_24V	B8	Sys_0V
A9	PE	B9	PE

DF58-M-4TC

 Thermocouple (TC) measurement module,
16 bit resolution, 4 channels

Specification	
Product	DF58-M-4TC
Number of channels	4
Data size	8 Byte
Signal type	Thermal resistance
Signal type	E(-200 ~ 1000°C) □ S(-50 ~ 1,768°C) □ J(-210 ~ 1,200°C) T(-200 ~ 400°C) □ K(-200 ~ 1,372°C) □ B(-50 ~ 1,820°C), N(-200 ~ 1300°C) □ C(0 ~ 2,315°C) □ R(-50 ~ 1,768°C) L(-200 ~ 900°C) □ U(-200 ~ 600°C)
Connection type	2/3/4-line
Reverse protection	Yes
Isolation method	Magnetic isolation between each channel and the field layer, and isolation between channels
Fault diagnosis	Yes
Resolution	16bit, 0.1°C/ each number
Frequency interference suppression	10Hz 50Hz 60Hz 400Hz
Diagnosis	Disconnection, Parameter assignment error
Process alarm	Upper/Lower limit, per channel
Temperature coefficient	≤50ppm/K .
Internal resistance	>500Ω
Precision	'max. 0.2 % FSR / 0.3 % FSR for Ni sensors / 0.6 % FSR for Cu10
Conversion time	36... 240ms, adjustable

Temperature module



RoHS

Product	DF58-M-4TC
---------	------------

Power Supply Parameters

Connection type	PUSH-IN type terminal block
Working voltage	24V DC +20 %/ -15 %
System feed current	<100mA
Maximum area of wire	1.5mm ²
Maximum area of wire (AWG)	AWG16
The minimum area of a wire	0.14mm ²
The minimum area of a wire (AWG)	AWG26
Strip length	8...10mm

Mechanical Structure

Protection grade	IP20
Size(H X W X D)	111mm X 12mm X 75mm
Installation type	35mm DIN

Work Environment

Working temperature	-25...60°C
Storage temperature	-40...85°C
Relative humidity	5... 95%RH(non-condensing)

LED Status Indicator

PW	Green : Power is working
ST	Green blinks : I/O system and modules working properly
LED	On: input signal is valid

Wiring Diagram

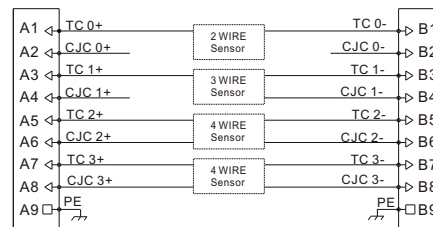
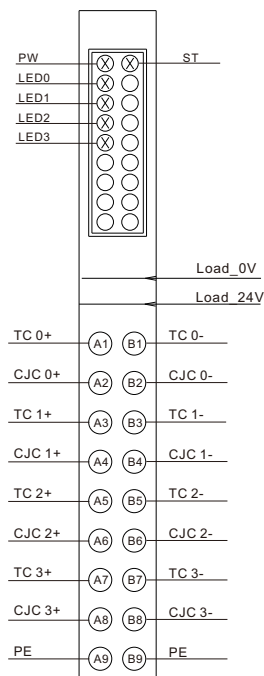

PIN definition

Mark	Description	Mark	Description
A1	TC 0+	B1	TC 0-
A2	CJC 0+	B2	CJC 0-
A3	TC 1+	B3	TC 1-
A4	CJC 1+	B4	CJC 1-
A5	TC 2+	B5	TC 2-
A6	CJC 2+	B6	CJC 2-
A7	TC 3+	B7	TC 3-
A8	CJC 3+	B8	CJC 3-
A9	PE	B9	PE

DF58-M-8TC

 Thermocouple (TC) measurement module,
 16 bit resolution, 8 channels

Specification	
Product	DF58-M-8TC
Number of channels	4
Data size	16 Byte
Signal type	Thermal resistance
Signal type	E(-200 ~ 1000°C) □ S(-50 ~ 1,768°C) □ J(-210 ~ 1,200°C) T(-200 ~ 400°C) □ K(-200 ~ 1,372°C) □ B(-50 ~ 1,820°C) □ N(-200 ~ 1300°C) □ C(0 ~ 2,315°C) □ R(-50 ~ 1,768°C) □ L(-200 ~ 900°C) □ U(-200 ~ 600°C)
Connection type	2-line
Reverse protection	Yes
Isolation method	Magnetic isolation between each channel and the field layer, and isolation between channels
Fault diagnosis	Yes
Resolution	16bit, 0.1°C/ each number
Frequency interference suppression	10Hz 50Hz 60Hz 400Hz
Diagnosis	Disconnection, Parameter assignment error
Process alarm	Upper/Lower limit, per channel
Temperature coefficient	≤50ppm/K
Internal resistance	>500Ω
Precision	'max. 0.2 % FSR / 0.3 % FSR for Ni sensors / 0.6 % FSR for Cu10
Conversion time	36... 240ms, adjustable

Temperature module



Product	DF58-M-8TC
---------	------------

Power Supply Parameters

Connection type	PUSH-IN type terminal block
Working voltage	24V DC +20 %/ -15 %
System feed current	<100mA
Maximum area of wire	1.5mm ²
Maximum area of wire (AWG)	AWG16
The minimum area of a wire	0.14mm ²
The minimum area of a wire (AWG)	AWG26
Strip length	8...10mm

Mechanical Structure

Protection grade	IP20
Size(H X W X D)	111mm X 12mm X 75mm
Installation type	35mm DIN

Work Environment

Working temperature	-25...60°C
Storage temperature	-40...85°C
Relative humidity	5... 95%RH(non-condensing)

LED Status Indicator

PW	Green : Power is working
ST	Green blinks : I/O system and modules working properly
LED	On: input signal is valid

Wiring Diagram

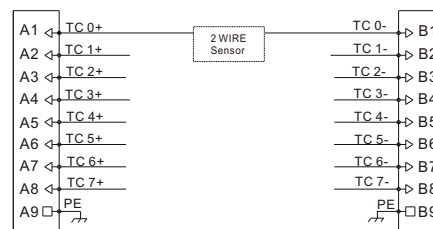
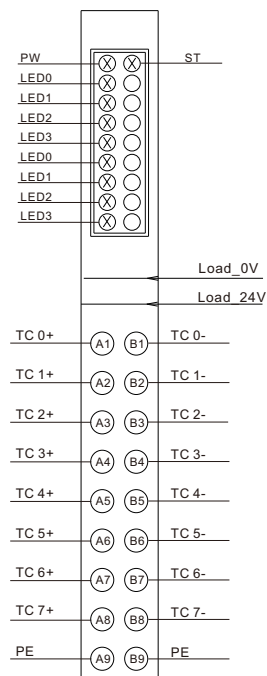

PIN definition

Mark	Description	Mark	Description
A1	TC 0+	B1	TC 0-
A2	TC 1+	B2	TC 1-
A3	TC 2+	B3	TC 2-
A4	TC 3+	B4	TC 3-
A5	TC 4+	B5	TC 4-
A6	TC 5+	B6	TC 5-
A7	TC 6+	B7	TC 6-
A8	TC 7+	B8	TC 7-
A9	PE	B9	PE

DF58 series dimension

DF58 series bus coupler dimension

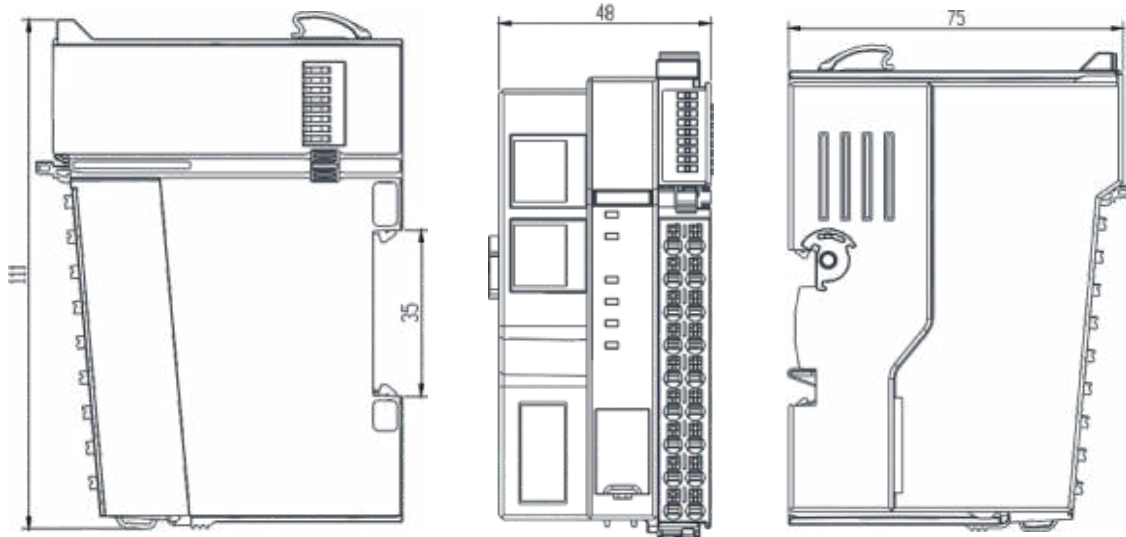

DF58 series I/O module & Terminal cover dimension

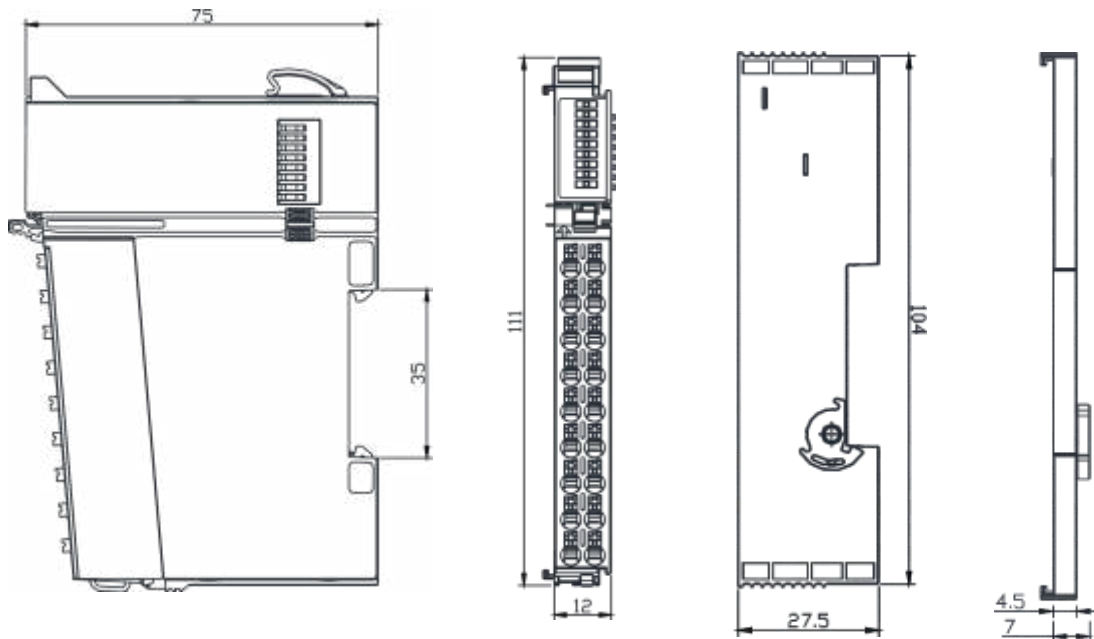

DF20 series I/O



- The DF20 series I/O system is the first generation I/O product
- Long term stable and reliable on-site application performance
- Pull back spring wiring, high vibration resistance
- The bus coupler supports 32 modules, all modules are powered from the side, and power modules are configured as needed

PROFINET Bus coupler



RoHS



DF20-C-PN-RT-V10

PROFINET, 2 RJ45, extensible 32 modules, 24VDC

Features

- With a power module.
- LED display working status, alarm and bus fault prompt.
- Two PROFINET interface (RJ45, 10/100Mbps).
- With Media Redundancy Protocol.

Specification

Product	DF20-C-PN-RT-V10
Communication protocol	PROFINET
Transmission rate	10/100Mbps, full duplex
Transmission distance	100 meters
PDO data	1024 bytes
Number of extensible modules	32
Address mapping	Yes
Address setting	PROFINET specification
Transmission medium	Class 5 twisted pair cable
Isolation method	Electrical isolation
Features	RT, conforming to Class C, MRP, automatic addressing/topology detection
Alarm function	Diagnostic alarm, process alarm, plug and unplug connector alarm
Minimum cycle time	1ms

Power Supply Parameters

Connection type	Spring terminal blocks
Working voltage	24V DC +20 %/ -15 %
Current without load	<350mA
Maximum area of wire	2.5mm ²
Maximum area of wire (AWG)	AWG14
The minimum area of a wire	0.2mm ²
The minimum area of a wire (AWG)	AWG28
Strip length	8...9mm
Supply system voltage	5VDC
Supply system current	Max.0.4A
Supply load voltage	24V...32VDC
Supply load current (MAX)	5A

PROFINET Bus coupler



Product	DF20-C-PN-RT-V10
Mechanical Structure	
Protection grade	IP20
Size(H X W X D)	100mm X 48mm X 69mm
Installation type	35mm DIN
Work Environment	
Working temperature	-25...60°C
Storage temperature	-40...85°C
Relative humidity	5... 95%RH(non-condensing)
LED Status Indicator	
PWR	Green: Power is working
RUN	Green: I/O system is running
LINK	Blinking green: The module is working
ERR	Red: An error occurred between I/O system and module
LED1	Green : PORT 1 connected successfully.
	Green blinking : Port 1 has data communication.
LED2	Green : PORT 2 connected successfully.
	Green blinking : Port 2 has data communication.
POWER-1, POWER-2	Green:The system power is working
POWER-7, POWER-8	Green: The load power is working
Support Module Types	
Digital module	DF20-M-8DI-N,DF20-M-8DI-P,DF20-M-16DI-N,DF20-M-16DI-P,DF20-M-32DI-N,DF20-M-32DI-P, DF20-M-8DO-N,DF20-M-8DO-P,DF20-M-16DO-N,DF20-M-16DO-P,DF20-M-32DO-N,DF20-M-32DO-P, DF20-M-8DIO-N,DF20-M-8DIO-P
Analog module	DF20-M-4AI-U-0,DF20-M-4AI-U-1,DF20-M-4AI-U-4,DF20-M-4AI-I-2,DF20-M-4AI-I-3,DF20-M-4AI-I-5,DF20-M-8AI-U-4,DF20-M-8AI-I-5,DF20-M-4AO-U-0,DF20-M-4AO-U-1,DF20-M-4AO-U-4,DF20-M-4AO-I-2,DF20-M-4AO-I-3,DF20-M-4AO-I-5,DF20-M-8AO-U-4,DF20-M-8AO-I-5
Functional module	DF20-M-2RTD-PT,DF20-M-4RTD-PT,DF20-M-4TC-KETJ,DF20-M-8TC-KETJ,DF20-M-2LC-S-5,DF20-M-1CNT-EL-5,DF20-M-1CNT-EL-4,DF20-M-2CNT-PIL-5,DF20-M-2CNT-PIL-4,DF20-M-1COM-232/485/422
Wiring Diagram	

Pin	Description
1	System_24V
2	System_0V
3	Load_24V
4	Load_24V
5	Load_0V
6	Load_0V
7	PE
8	PE

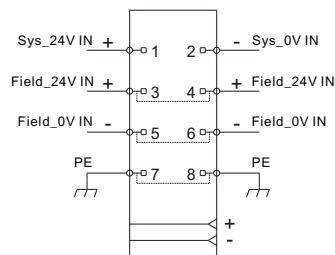

DF20-C-PN-RT-V10

EtherCAT Bus coupler



DF20-C-EC

EtherCAT, 2 RJ45, extensible 31 modules, 24VDC

Features

- With a power module.
- LED display working status, alarm and bus fault prompt.
- Two EtherCAT interface (RJ45, 100Mbps).

Specification

Product	DF20-C-EC
Communication protocol	EtherCAT
Connection type	2 X RJ45, with switch function
Transmission rate	10/100Mbps, full duplex
Transmission distance	100 meters
PDO data	1024 bytes
Number of extensible modules	31
Address mapping	Yes
Address setting	EtherCAT specification, DIP switch
Alias range	1~254
Transmission medium	Class 5 twisted pair cable
Isolation method	Electrical isolation

Power Supply Parameters

Connection type	Spring terminal blocks
Working voltage	24VDC +20 %/ -15 %
Current without load	<150mA
Maximum area of wire	2.5mm ²
Maximum area of wire (AWG)	AWG14
The minimum area of a wire	0.2mm ²
The minimum area of a wire (AWG)	AWG28
Strip length	8...9mm
Supply system voltage	5VDC
Supply system current	Max.0.6A
Supply load voltage	24V...32VDC
Supply load current (MAX)	5A

EtherCAT Bus coupler



RoHS

Product	DF20-C-EC
Mechanical Structure	
Protection grade	IP20
Size(H X W X D)	100mm X 48mm X 69mm
Installation type	35mm DIN
Work Environment	
Working temperature	-25...60°C
Storage temperature	-40...85°C
Relative humidity	5... 95%RH(non-condensing)
LED Status Indicator	
PWR	Green: Power is working
RUN	Green Off: The I/O system is being initialized.
	Green slow blinking: The I/O system is prerunning.
	Green fast blinking: The I/O system is operating safely.
	Green: The I/O system is running.
LINK	Blinking green: The module is working.
ERR	Red: An error occurred between I/O system and module.
LED1	/
LED2	/
POWER-1, POWER-2	Green: The system power is working.
POWER-7, POWER-8	Green: The load power is working.
Support Module Types	
Digital module	DF20-M-8DI-N,DF20-M-8DI-P,DF20-M-16DI-N,DF20-M-16DI-P,DF20-M-32DI-N,DF20-M-32DI-P DF20-M-8DO-N,DF20-M-8DO-P,DF20-M-16DO-N,DF20-M-16DO-P,DF20-M-32DO-N,DF20-M-32DO-P DF20-M-8DIO-N,DF20-M-8DIO-P
Analog module	DF20-M-4AI-U-0,DF20-M-4AI-U-1,DF20-M-4AI-U-4,DF20-M-4AI-I-2,DF20-M-4AI-I-3,DF20-M-4AI-I-5,DF20-M-8AI-U-4,DF20-M-8AI-I-5,DF20-M-4AO-U-0,DF20-M-4AO-U-1,DF20-M-4AO-U-4,DF20-M-4AO-I-2,DF20-M-4AO-I-3,DF20-M-4AO-I-5,DF20-M-8AO-U-4,DF20-M-8AO-I-5
Functional module	DF20-M-2RTD-PT,DF20-M-4RTD-PT,DF20-M-4TC-KETJ,DF20-M-8TC-KETJ DF20-M-2LC-S-5,DF20-M-1CNT-EL-5,DF20-M-1CNT-EL-4,DF20-M-2CNT-PIL-5,DF20-M-2CNT-PIL-4,DF20-M-1CNT-ELP-5,DF20-M-1COM-232/485/422
Wiring Diagram	

Pin	Description
1	System_24V
2	System_0V
3	Load_24V
4	Load_24V
5	Load_0V
6	Load_0V
7	PE
8	PE

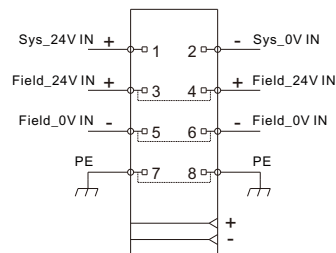

DF20-C-EC



DF20-C-EN-IP

Features

- With a power module.
- LED display working status, alarm and bus fault prompt.
- Two EtherNet/IP interface (RJ45, 10/100Mbps).

EtherNet/IP, 2 RJ45, extensible 32 modules, 24VDC

Specification

Product	DF20-C-EN-IP
Communication protocol	EtherNet/IP
Transmission rate	10/100Mbps, full duplex
Transmission distance	100 meters
PDO data	1024 bytes
Number of extensible modules	32
Address mapping	yes
Address setting	EtherNet/IP specification, DIP switch
Transmission medium	Class 5 twisted pair cable
Isolation method	Electrical isolation
Alarm function	Diagnostic alarm, process alarm, plug and unplug connector alarm
Minimum cycle time	1ms

Power Supply Parameters

Connection type	Spring terminal blocks
Working voltage	24V DC +20 %/ -15 %
Current without load	<350mA
Maximum area of wire	2.5mm ²
Maximum area of wire (AWG)	AWG14
The minimum area of a wire	0.2mm ²
The minimum area of a wire (AWG)	AWG28
Strip length	8...9mm
Supply system voltage	5VDC
Supply system current	Max.0.4A
Supply load voltage	24V...32VDC
Supply load current (MAX)	5A

EtherNet/IP Bus coupler



RoHS

Product	DF20-C-EN-IP
Mechanical Structure	
Protection grade	IP20
Size(H X W X D)	100mm X 48mm X 69mm
Installation type	35mm DIN
Work Environment	
Working temperature	-25...60°C
Storage temperature	-40...85°C
Relative humidity	5... 95%RH(non-condensing)
LED Status Indicator	
PWR	Green: Power is working
RUN	Green: I/O system is running
LINK	Blinking green: The module is working
ERR	Red: An error occurred between I/O system and module
LED1	Green : PORT 1 connected successfully.
	Green blinking : Port 1 has data communication.
LED2	Green : PORT 2 connected successfully.
	Green blinking : Port 2 has data communication.
POWER-1, POWER-2	Green:The system power is working
POWER-7, POWER-8	Green: The load power is working
Support Module Types	
Digital module	DF20-M-8DI-N,DF20-M-8DI-P,DF20-M-16DI-N,DF20-M-16DI-P DF20-M-8DO-N,DF20-M-8DO-P,DF20-M-16DO-N,DF20-M-16DO-P DF20-M-8DIO-N,DF20-M-8DIO-P
Analog module	DF20-M-4AI-U-0,DF20-M-4AI-U-1,DF20-M-4AI-U-4,DF20-M-4AI-I-2,DF20-M-4AI-I-3,DF20-M-4AI-I-5, DF20-M-4AO-U-0,DF20-M-4AO-U-1,DF20-M-4AO-U-4,DF20-M-4AO-I-2,DF20-M-4AO-I-3,DF20-M-4AO-I-5
Functional module	DF20-M-2RTD-PT,DF20-M-4RTD-PT,DF20-M-4TC-KETJ,DF20-M-8TC-KETJ DF20-M-2LC-S-5,DF20-M-1CNT-EL-5,DF20-M-1CNT-EL-4,DF20-M-2CNT-PIL-5,DF20-M-2CNT-PIL-4
Wiring Diagram	

Pin	Description
1	System_24V
2	System_0V
3	Load_24V
4	Load_24V
5	Load_0V
6	Load_0V
7	PE
8	PE

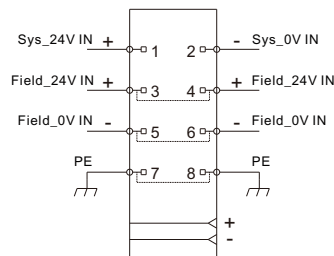

DF20-C-EN-IP

Modbus TCP/IP Bus coupler

RoHS

DF20-C-MD-TCP-V1
Features

- With a power module.
- LED display working status, alarm and bus fault prompt.
- Modbus TCP/IP interface (RJ45, 10/100Mbps)

Modbus TCP/IP, 1 RJ45, extensible 16 modules, 24VDC

Specification

Product	DF20-C-MD-TCP-V1
Communication protocol	Modbus TCP/IP
Transmission rate	10/100Mbps
Transmission distance	100 meters
PDO data	1024 bytes
Number of extensible modules	16
Support Modbus function	02,03,05,06,15,16
Address mapping	Yes
Address setting	Modbus TCP/IP specification, DIP switch
Address range	2~253
Transmission medium	Class 5 twisted pair cable
Isolation method	Electrical isolation

Power Supply Parameters

Connection type	Spring terminal blocks
Working voltage	24V DC +20 %/ -15 %
Current without load	<150mA
Maximum area of wire	2.5mm ²
Maximum area of wire (AWG)	AWG14
The minimum area of a wire	0.2mm ²
The minimum area of a wire (AWG)	AWG28
Strip length	8...9mm
Supply system voltage	5VDC
Supply system current	Max.0.6A
Supply load voltage	24V...32VDC
Supply load current (MAX)	5A

Modbus TCP/IP Bus coupler



RoHS

Product	DF20-C-MD-TCP-V1
Mechanical Structure	
Protection grade	IP20
Size(H X W X D)	100mm X 48mm X 69mm
Installation type	35mm DIN
Work Environment	
Working temperature	-25...60°C
Storage temperature	-40...85°C
Relative humidity	5... 95%RH(non-condensing)
LED Status Indicator	
PWR	Green: Power is working
RUN	Green: I/O system is running
LINK	Blinking green: The module is working
ERR	Red: An error occurred between I/O system and module
LED1	/
LED2	/
POWER-1, POWER-2	Green:The system power is working
POWER-7, POWER-8	Green: The load power is working
Support Module Types	
Digital module	DF20-M-8DI-N,DF20-M-8DI-P,DF20-M-16DI-N,DF20-M-16DI-P,DF20-M-32DI-N,DF20-M-32DI-P,DF20-M-8DO-N,DF20-M-8DO-P,DF20-M-16DO-N,DF20-M-16DO-P,DF20-M-32DO-N,DF20-M-32DO-P
Analog module	DF20-M-4AI-U-0,DF20-M-4AI-U-1,DF20-M-4AI-U-4,DF20-M-4AI-I-2,DF20-M-4AI-I-3,DF20-M-4AI-I-5,DF20-M-4AO-U-0,DF20-M-4AO-U-1,DF20-M-4AO-U-4,DF20-M-4AO-I-2,DF20-M-4AO-I-3,DF20-M-4AO-I-5
Functional module	DF20-M-2RTD-PT,DF20-M-4RTD-PT,DF20-M-4TC-KETJ,DF20-M-8TC-KETJ,DF20-M-2LC-S-5,DF20-M-1CNT-EL-5,DF20-M-1CNT-EL-4,DF20-M-2CNT-PIL-5,DF20-M-2CNT-PIL-4
Wiring Diagram	

Pin	Description
1	System_24V
2	System_0V
3	Load_24V
4	Load_24V
5	Load_0V
6	Load_0V
7	PE
8	PE

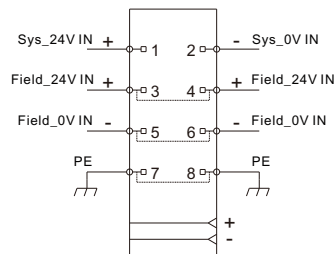

DF20-C-MD-TCP-V1

Digital input module



RoHS



DF20-M-8DI-N



DF20-M-8DI-P



DF20-M-16DI-N



DF20-M-16DI-P



DF20-M-32DI-N



DF20-M-32DI-P

NPN , 24VDC Digital input module, 8 ports, NPN, 24VDC	PNP , 24VDC Digital input module, 8 ports, PNP, 24VDC	NPN , 24VDC Digital input module, 16 ports, NPN, 24VDC	PNP , 24VDC Digital input module, 16 ports, PNP, 24VDC	NPN , 24VDC Digital input module, 32 ports, NPN, 24VDC	PNP , 24VDC Digital input module, 32 ports, PNP, 24VDC
---	---	--	--	--	--

Specification

Product	DF20-M-8DI-N	DF20-M-8DI-P	DF20-M-16DI-N	DF20-M-16DI-P	DF20-M-32DI-N	DF20-M-32DI-P
Number of channels	8		16		32	
Data size	1 Byte		2 Byte		4 Byte	
Signal type	NPN	PNP	NPN	PNP	NPN	PNP
"0" signal voltage	18V...32V	0V...4V	18V...32V	0V...4V	18V...32V	0V...4V
"1" signal voltage	0V...4V	18V...32V	0V...4V	18V...32V	0V...4V	18V...32V
Connection type	1-line					
Reverse protection	Yes					
Isolation method	Photoelectric isolation					
Fault diagnosis	Yes					
Typical input current	3mA					
Filtering time	0.3ms					
Precision	0.20%					

Power Supply Parameters

Connection type	Spring terminal blocks					
Working voltage	24V DC +20 %/ -15 %					
System feed current	<14mA		<15mA		<30mA	
Maximum area of wire	2.5mm ²		1.5mm ²			
Maximum area of wire (AWG)	AWG14		AWG16			
The minimum area of a wire	0.2mm ²		0.2mm ²			
The minimum area of a wire (AWG)	AWG28		AWG28			
Strip length	8...9mm		8...9mm			

Digital input module



Product	DF20-M-8DI-N	DF20-M-8DI-P	DF20-M-16DI-N	DF20-M-16DI-P	DF20-M-32DI-N	DF20-M-32DI-P
Mechanical Structure						
Protection grade	IP20					
Size(H X W X D)	100mm X 12mm X 69mm			100mm X 24mm X 69mm		
Installation type	35mm DIN					
Work Environment						
Working temperature	-25...60°C					
Storage temperature	-40...85°C					
Relative humidity	5... 95%RH(non-condensing)					
LED Status Indicator						
Channel Light	Green: The input signal of each channel is working.					
Wiring Diagram						

Pin	Description
1	Input 0
2	Input 1
3	Input 2
4	Input 3
5	Input 4
6	Input 5
7	Input 6
8	Input 7

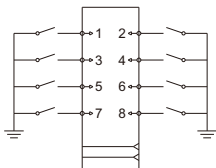

DF20-M-8DI-N

Pin	Description	Pin	Description
1	Input 0	9	Input 8
2	Input 1	10	Input 9
3	Input 2	11	Input 10
4	Input 3	12	Input 11
5	Input 4	13	Input 12
6	Input 5	14	Input 13
7	Input 6	15	Input 14
8	Input 7	16	Input 15

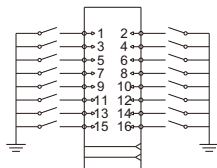

DF20-M-16DI-N

Pin	Description
1	Input 0
2	Input 1
3	Input 2
4	Input 3
5	Input 4
6	Input 5
7	Input 6
8	Input 7

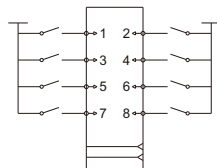

DF20-M-8DI-P

Pin	Description	Pin	Description
1	Input 0	9	Input 8
2	Input 1	10	Input 9
3	Input 2	11	Input 10
4	Input 3	12	Input 11
5	Input 4	13	Input 12
6	Input 5	14	Input 13
7	Input 6	15	Input 14
8	Input 7	16	Input 15

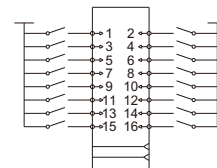

DF20-M-16DI-P

Pin	Description	Pin	Description	Pin	Description	Pin	Description
1	Input 0	9	Input 8	17	Input 16	25	Input 24
2	Input 1	10	Input 9	18	Input 17	26	Input 25
3	Input 2	11	Input 10	19	Input 18	27	Input 26
4	Input 3	12	Input 11	20	Input 19	28	Input 27
5	Input 4	13	Input 12	21	Input 20	29	Input 28
6	Input 5	14	Input 13	22	Input 21	30	Input 29
7	Input 6	15	Input 14	23	Input 22	31	Input 30
8	Input 7	16	Input 15	24	Input 23	32	Input 31

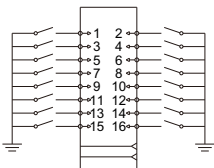

DF20-M-32DI-N

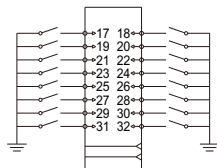

DF20-M-32DI-P

Pin	Description	Pin	Description	Pin	Description	Pin	Description
1	Input 0	9	Input 8	17	Input 16	25	Input 24
2	Input 1	10	Input 9	18	Input 17	26	Input 25
3	Input 2	11	Input 10	19	Input 18	27	Input 26
4	Input 3	12	Input 11	20	Input 19	28	Input 27
5	Input 4	13	Input 12	21	Input 20	29	Input 28
6	Input 5	14	Input 13	22	Input 21	30	Input 29
7	Input 6	15	Input 14	23	Input 22	31	Input 30
8	Input 7	16	Input 15	24	Input 23	32	Input 31

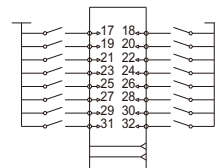
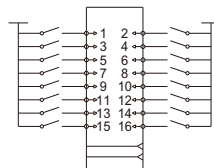

Digital output module



DF20-M-8DO-N



DF20-M-8DO-P



DF20-M-16DO-N



DF20-M-16DO-P



DF20-M-32DO-N



DF20-M-32DO-P

NPN , 24VDC Digital output module, 8 ports, NPN, 24VDC	PNP , 24VDC Digital output module, 8 ports, PNP, 24VDC	NPN , 24VDC Digital output module, 16 ports, NPN, 24VDC	PNP , 24VDC Digital output module, 16 ports, PNP, 24VDC	NPN , 24VDC Digital output module, 32 ports, NPN, 24VDC	PNP , 24VDC Digital output module, 32 ports, PNP, 24VDC
--	--	---	---	---	---

Specification

Product	DF20-M-8DO-N	DF20-M-8DO-P	DF20-M-16DO-N	DF20-M-16DO-P	DF20-M-32DO-N	DF20-M-32DO-P
Number of channels	8		16		32	
Data size	1 Byte		2 Byte		4 Byte	
Signal type	NPN	PNP	NPN	PNP	NPN	PNP
"0" signal voltage	high-impedance state	high-impedance state	high-impedance state	high-impedance state	high-impedance state	high-impedance state
"1" signal voltage	0V DC	24V DC	0V DC	24V DC	0V DC	24V DC
Connection type	1-line					
Reverse protection	Yes					
Isolation method	Photoelectric isolation					
Switching Frequency (resistance/lamp load)	<1000Hz					
Switching Frequency (Inductive load)	<0.2Hz					
Response Time of the Protection Circuit	< 100µs					
Output current per channel(MAX)	500 mA					
Load type	Inductance, resistance, lamp					

Power Supply Parameters

Connection type	Spring terminal blocks					
Working voltage	24V DC +20 %/ -15 %					
System feed current	<50mA		<75mA		<100mA	
Maximum area of wire	2.5mm ²		1.5mm ²			
Maximum area of wire (AWG)	AWG14		AWG16			
The minimum area of a wire	0.2mm ²		0.2mm ²			
The minimum area of a wire (AWG)	AWG28		AWG28			
Strip length	8...9mm		8...9mm			

Digital output module



Product	DF20-M-8DO-N	DF20-M-8DO-P	DF20-M-16DO-N	DF20-M-16DO-P	DF20-M-32DO-N	DF20-M-32DO-P
---------	--------------	--------------	---------------	---------------	---------------	---------------

Mechanical Structure

Protection grade	IP20	
Size(H X W X D)	100mm X 12mm X 69mm	100mm X 24mm X 69mm
Installation type	35mm DIN	

Work Environment

Working temperature	-25...60°C
Storage temperature	-40...85°C
Relative humidity	5... 95%RH(non-condensing)

LED Status Indicator

Channel Light	Green: The output signal of each channel is working.
---------------	--

Wiring Diagram

Pin	Description
1	Output 0
2	Output 1
3	Output 2
4	Output 3
5	Output 4
6	Output 5
7	Output 6
8	Output 7

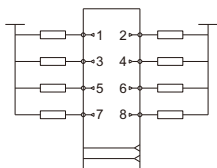

DF20-M-8DO-N

Pin	Description	Pin	Description
1	Output 0	9	Output 8
2	Output 1	10	Output 9
3	Output 2	11	Output 10
4	Output 3	12	Output 11
5	Output 4	13	Output 12
6	Output 5	14	Output 13
7	Output 6	15	Output 14
8	Output 7	16	Output 15

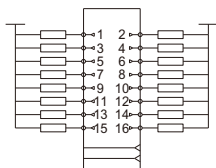

DF20-M-16DO-N

Pin	Description
1	Output 0
2	Output 1
3	Output 2
4	Output 3
5	Output 4
6	Output 5
7	Output 6
8	Output 7

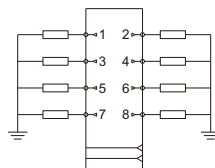

DF20-M-8DO-P

Pin	Description	Pin	Description
1	Output 0	9	Output 8
2	Output 1	10	Output 9
3	Output 2	11	Output 10
4	Output 3	12	Output 11
5	Output 4	13	Output 12
6	Output 5	14	Output 13
7	Output 6	15	Output 14
8	Output 7	16	Output 15

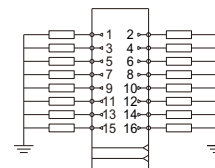

DF20-M-16DO-P

Pin	Description	Pin	Description	Pin	Description	Pin	Description
1	Output 0	9	Output 8	17	Output 16	25	Output 24
2	Output 1	10	Output 9	18	Output 17	26	Output 25
3	Output 2	11	Output 10	19	Output 18	27	Output 26
4	Output 3	12	Output 11	20	Output 19	28	Output 27
5	Output 4	13	Output 12	21	Output 20	29	Output 28
6	Output 5	14	Output 13	22	Output 21	30	Output 29
7	Output 6	15	Output 14	23	Output 22	31	Output 30
8	Output 7	16	Output 15	24	Output 23	32	Output 31

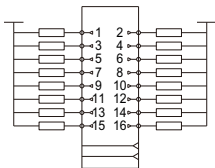

DF20-M-32DO-N

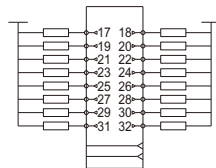

DF20-M-32DO-P

Pin	Description	Pin	Description	Pin	Description	Pin	Description
1	Output 0	9	Output 8	17	Output 16	25	Output 24
2	Output 1	10	Output 9	18	Output 17	26	Output 25
3	Output 2	11	Output 10	19	Output 18	27	Output 26
4	Output 3	12	Output 11	20	Output 19	28	Output 27
5	Output 4	13	Output 12	21	Output 20	29	Output 28
6	Output 5	14	Output 13	22	Output 21	30	Output 29
7	Output 6	15	Output 14	23	Output 22	31	Output 30
8	Output 7	16	Output 15	24	Output 23	32	Output 31

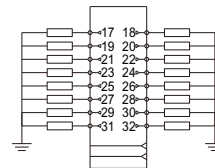
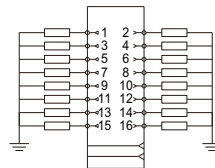

Analog input module



DF20-M-4AI-U-0



DF20-M-4AI-U-1



DF20-M-4AI-U-4



DF20-M-8AI-U-4

Analog input module, 4 ports, -10... 10V, voltage type

Analog input module, 4 ports, 0... 10V, voltage type

Analog input module, 4 ports, (0...+10V)(-10...+10V), voltage type

Analog input module, 8 ports, (0...+10V)(-10...+10V), voltage type

Specification

Product	DF20-M-4AI-U-0	DF20-M-4AI-U-1	DF20-M-4AI-U-4	DF20-M-8AI-U-4
Number of channels	4			8
Data size	8 Byte			16 Byte
Measuring range	Voltage U (-10... 10 V)	Voltage U (0... 10 V)	Voltage U (0...+10V) (-10...+10V)	Voltage U (0...+10V)(-10...+10V)
Signal type	Differential signal			
Connection type	2-line			
Reverse protection	Yes			
Isolation method	Magnetic isolation			
Fault diagnosis	Yes			
Internal Resistance	>450KΩ			
Resolution	16 Bit			
Measuring range(Profinet/Ethernet IP)	(-10...+10V): -27648~27648	(0...+10V): 0~27648	(0...+10V): 0~27648 (-10...+10V): -27648~27648	(0...+10V): 0~27648 (-10...+10V): -27648~27648
Measuring range(Others)	(-10...+10V): -32768~32767	(0...+10V): 0~65535	(0...+10V): 0~32767 (-10...+10V): -32768~32767	(0...+10V): 0~32767 (-10...+10V): -32768~32767
Precision	0.20%			
Conversion time	< 1ms			
Sampling rate	20-300Hz (Configuration)			

Power Supply Parameters

Connection type	Spring terminal blocks		
Working voltage	24V DC +20 % / -15 %		
System feed current	<120mA		<200mA
Maximum area of wire	2.5mm ²		1.5mm ²
Maximum area of wire (AWG)	AWG14		AWG16
The minimum area of a wire	0.2mm ²		0.2mm ²
The minimum area of a wire (AWG)	AWG28		AWG28
Strip length	8...9mm		8...9mm

Analog input module



Product	DF20-M-4AI-U-0	DF20-M-4AI-U-1	DF20-M-4AI-U-4	DF20-M-8AI-U-4
Mechanical Structure				
Protection grade	IP20			
Size(H X W X D)	100mm X 12mm X 69mm			
Installation type	35mm DIN			
Work Environment				
Working temperature	-25...60°C			
Storage temperature	-40...85°C			
Relative humidity	5... 95%RH(non-condensing)			

LED Status Indicator

LED1	Green: Power is working	Green: Signal on Channel 1.
LED2	Green blinks: I/O system and modules working properly	Green: Signal on Channel 2.
LED3	—	Green: Signal on Channel 3.
LED4	—	Green: Signal on Channel 4.
LED5	—	Green: Signal on Channel 5.
LED6	—	Green: Signal on Channel 6.
LED7	—	Green: Signal on Channel 7.
LED8	—	Green: Signal on Channel 8.
PWR	—	Green: Power is working.
L/A	—	Green: I/O system and modules working properly.

Wiring Diagram

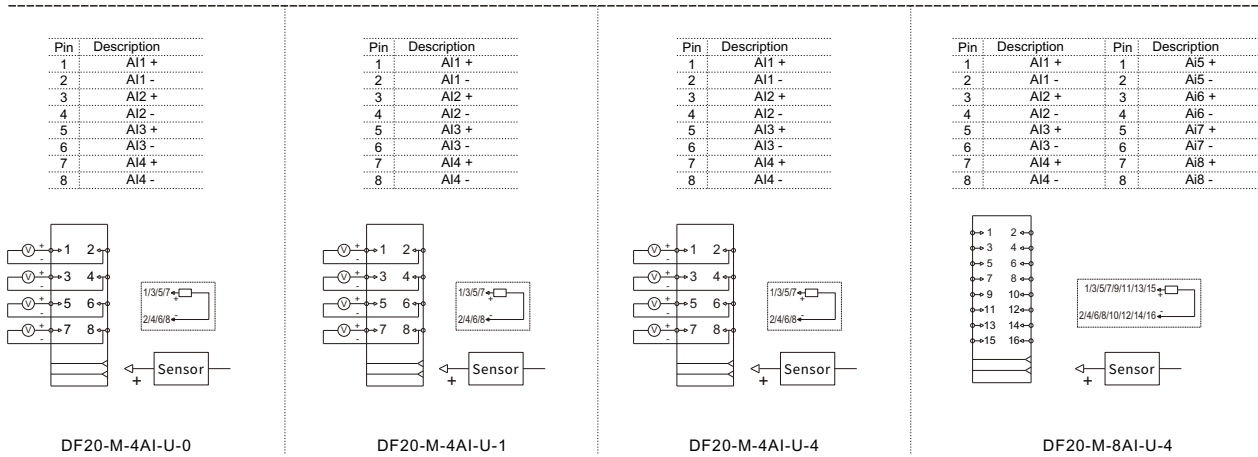

Analog input module



DF20-M-4AI-I-2



DF20-M-4AI-I-3



DF20-M-4AI-I-5



DF20-M-8AI-I-5

Analog input module, 4 ports, 0... 20 mA, current type

Analog input module, 4 ports, 4... 20 mA, current type

Analog input module, 4 ports, (0...20mA)(4...20mA), current type

Analog input module, 8 ports, (0...20mA)(4...20mA), current type

Specification

Product	DF20-M-4AI-I-2	DF20-M-4AI-I-3	DF20-M-4AI-I-5	DF20-M-8AI-I-5
Number of channels	4			8
Data size	8 Byte			16 Byte
Measuring range	Current(0..20ma)	Current(4..20ma)	Current I(0...20mA)(4...20mA)	Current I(0...20mA)(4...20mA)
Signal type	Differential signal			
Connection type	2-line			
Reverse protection	Yes			
Isolation method	Magnetic isolation			
Fault diagnosis	Yes			
Internal Resistance	100Ω			
Resolution	16 Bit			
Measuring range(Profinet/Ethernet IP)	(0..20ma)0~27648	(4..20ma)0~27648	(0/4..20ma)0~27648	(0/4..20ma)0~27648
Measuring range(Others)	(0..20ma)0~65535	(4..20ma)0~65535	(0/4..20ma)0~65535	(0/4..20ma)0~65535
Precision	0.20%/±50ppm/K max.			
Conversion time	< 1ms			
Sampling rate	20-300Hz (Configuration)			

Power Supply Parameters

Connection type	Spring terminal blocks		
Working voltage	24V DC +20 %/ -15 %		
System feed current	<120mA		<200mA
Maximum area of wire	2.5mm ²		1.5mm ²
Maximum area of wire (AWG)	AWG14		AWG16
The minimum area of a wire	0.2mm ²		0.2mm ²
The minimum area of a wire (AWG)	AWG28		AWG28
Strip length	8...9mm		8...9mm

Analog input module



Product	DF20-M-4AI-I-2	DF20-M-4AI-I-3	DF20-M-4AI-I-5	DF20-M-8AI-I-5
---------	----------------	----------------	----------------	----------------

Mechanical Structure

Protection grade	IP20
Size(H X W X D)	100mm X 12mm X 69mm
Installation type	35mm DIN

Work Environment

Working temperature	-25...60°C
Storage temperature	-40...85°C
Relative humidity	5... 95%RH(non-condensing)

LED Status Indicator

LED1	Green : Power is working	Green: Signal on Channel 1.
LED2	Green blinks : I/O system and modules working properly	Green: Signal on Channel 2.
LED3	—	Green: Signal on Channel 3.
LED4	—	Green: Signal on Channel 4.
LED5	—	Green: Signal on Channel 5.
LED6	—	Green: Signal on Channel 6.
LED7	—	Green: Signal on Channel 7.
LED8	—	Green: Signal on Channel 8.
PWR	—	Green: Power is working
L/A	—	Green: I/O system and modules working properly

Wiring Diagram

Pin	Description
1	AI1 +
2	AI1 -
3	AI2 +
4	AI2 -
5	AI3 +
6	AI3 -
7	AI4 +
8	AI4 -

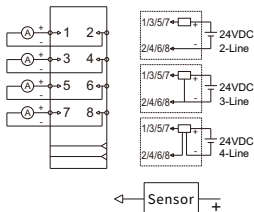

DF20-M-4AI-I-2

Pin	Description
1	AI1 +
2	AI1 -
3	AI2 +
4	AI2 -
5	AI3 +
6	AI3 -
7	AI4 +
8	AI4 -

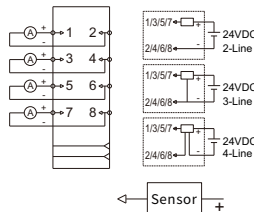

DF20-M-4AI-I-3

Pin	Description
1	AI1 +
2	AI1 -
3	AI2 +
4	AI2 -
5	AI3 +
6	AI3 -
7	AI4 +
8	AI4 -

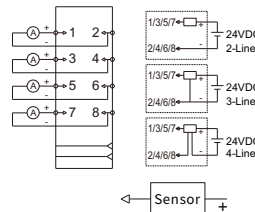

DF20-M-4AI-I-5

Pin	Description	Pin	Description
1	AI1 +	9	AI5 +
2	AI1 -	10	AI5 -
3	AI2 +	11	AI6 +
4	AI2 -	12	AI6 -
5	AI3 +	13	AI7 +
6	AI3 -	14	AI7 -
7	AI4 +	15	AI8 +
8	AI4 -	16	AI8 -

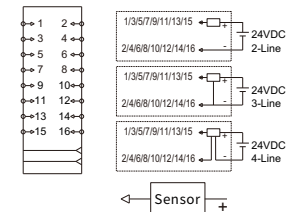

DF20-M-8AI-I-5

Analog output module



RoHS



DF20-M-4AO-U-0

DF20-M-4AO-U-1

DF20-M-4AO-U-4

DF20-M-4AO-I-2

DF20-M-4AO-I-3

DF20-M-4AO-I-5

Analog output module, 4 ports, -10... 10V, voltage type	Analog output module, 4 ports, 0... 10V, voltage type	Analog output module, 4 ports, -10...+10V, 0... 10V, voltage type	Analog output module, 4 ports, 0... 20 mA, current type	Analog output module, 4 ports, 4... 20 mA, current type	Analog output module, 4 ports, 0...20mA, 4... 20 mA, current type
---	---	---	---	---	---

Specification

Product	DF20-M-4AO-U-0	DF20-M-4AO-U-1	DF20-M-4AO-U-4	DF20-M-4AO-I-2	DF20-M-4AO-I-3	DF20-M-4AO-I-5
Number of channels	4					
Data size	8 Byte					
Signal type	Differential signal					
Connection type	2-line					
Overcurrent protection	Yes					
Isolation method	Magnetic isolation					
Fault diagnosis	Yes					
Resolution	16 Bit					
Precision	0.10%					
Measuring range(Profinet/Ethernet IP)	(-10...+10V)-27648-27648	(0...+10V):0~27648	(0...+10V): 0-27648 (-10...+10V): -27648-27648	(0..20ma)0-27648	(4..20ma)0-27648	(0/4..20ma)0-27648
Measuring range(Others)	(-10...+10V)-32768-32767	(0...+10V): 0-65535	(0...+10V): 0-32767 (-10...+10V): -32768-32767	(0..20ma)0-65535	(4..20ma)0-65535	(0/4..20ma)0-65535
Temperature coefficient	<20 ppm					
Conversiontime	≤ 1ms					
Load impedance	>2KΩ			<250Ω		

Power Supply Parameters

Connection type	Spring terminal blocks					
Working voltage	24V DC +20 %/ -15 %					
System feed current	<200mA			<400mA		
Maximum area of wire	2.5mm ²					
Maximum area of wire (AWG)	AWG14					
The minimum area of a wire	0.2mm ²					
The minimum area of a wire (AWG)	AWG28					
Strip length	8...9mm					

Analog output module



Product	DF20-M-4AO-U-0	DF20-M-4AO-U-1	DF20-M-4AO-U-4	DF20-M-4AO-I-2	DF20-M-4AO-I-3	DF20-M-4AO-I-5
---------	----------------	----------------	----------------	----------------	----------------	----------------

Mechanical Structure

Protection grade	IP20					
Size(H X W X D)	100mm X 12mm X 69mm					
Installation type	35mm DIN					

Work Environment

Working temperature	-25...60°C					
Storage temperature	-40...85°C					
Relative humidity	5... 95%RH(non-condensing)					

LED Status Indicator

LED1	Green : Power is working					
LED2	Green blinks : I/O system and modules working properly					

Wiring Diagram

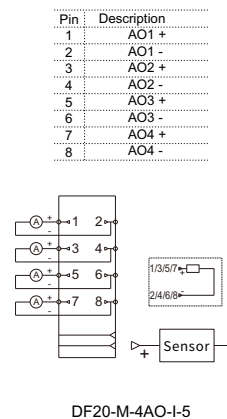
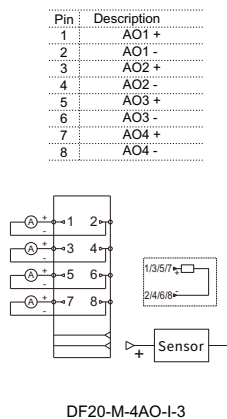
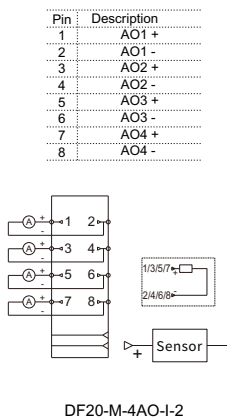
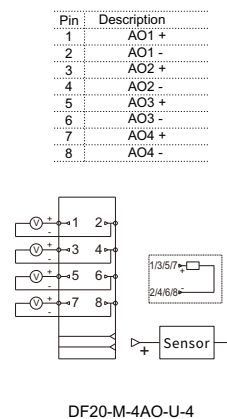
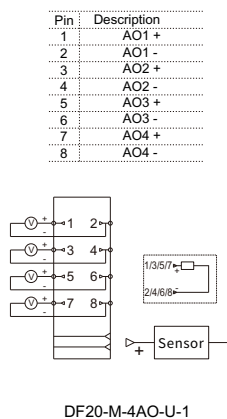
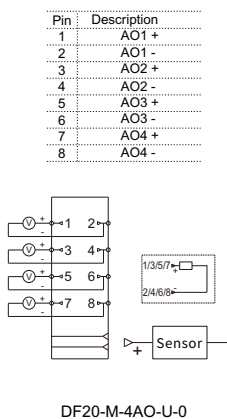

DF20-M-2RTD-PT

 Thermal Resistance (RTD) measurement module,
16 bit resolution, 2 channels

DF20-M-4RTD-PT

 Thermal Resistance (RTD) measurement module,
16 bit resolution, 4 channels

Specification

Specification	DF20-M-2RTD-PT	DF20-M-4RTD-PT
Product	DF20-M-2RTD-PT	DF20-M-4RTD-PT
Number of channels	2	4
Data size	4 Byte	8 Byte
Signal type	Thermal resistance	
Signal type	PT100, PT1000	
Connection type	2/3/4-line	2/3-line
Reverse protection	Yes	
Isolation method	Magnetic isolation	
Fault diagnosis	Yes	
Resolution	16bit, 0.1°C/ each number	
Frequency interference suppression	10Hz 50Hz 60Hz 400Hz	
Diagnosis	Disconnection, Parameter assignment error	
Process alarm	Upper/Lower limit, per channel	
Temperature coefficient	±50ppm/K max.	
Measuring range	-200°C ~ 850°C	
Precision	±0.3%	
Conversion time	150ms	200ms

Temperature module



RoHS

Product	DF20-M-2RTD-PT	DF20-M-4RTD-PT
---------	----------------	----------------

Power Supply Parameters

Connection type	Spring terminal blocks	
Working voltage	24V DC +20 %/ -15 %	
System feed current	<60mA	<100mA
Maximum area of wire	2.5mm ²	1.5mm ²
Maximum area of wire (AWG)	AWG14	AWG16
The minimum area of a wire	0.2mm ²	0.2mm ²
The minimum area of a wire (AWG)	AWG28	AWG28
Strip length	8...9mm	8...9mm

Mechanical Structure

Protection grade	IP20
Size(H X W X D)	100mm X 12mm X 69mm
Installation type	35mm DIN

Work Environment

Working temperature	-25...60°C
Storage temperature	-40...85°C
Relative humidity	5... 95%RH(non-condensing)

LED Status Indicator

LED1	Green : Power is working
LED2	Green blinks : I/O system and modules working properly

Wiring Diagram

Pin	Description
1	+R1
2	+R2
3	+R11
4	+R12
5	-R1
6	-R2
7	-R11
8	-R12

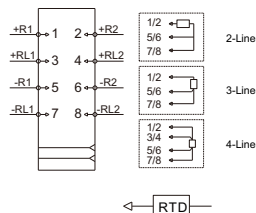

DF20-M-2RTD-PT

Pin	Description	Pin	Description
1	+R1	1	+R3
2	/	2	/
3	-R1	3	-R3
4	-R11	4	-R13
5	+R2	5	+R4
6	/	6	/
7	-R12	7	-R14
8	-R2	8	-R4

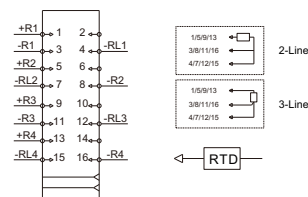

DF20-M-4RTD-PT

DF20-M-4TC-KETJ

 Thermocouple (TC) module, 4 inputs,
16 bit resolution

DF20-M-8TC-KETJ

 Thermocouple (TC) module, 8 inputs,
16 bit resolution

Specification

Product	DF20-M-4TC-KETJ	DF20-M-8TC-KETJ
Number of channels	4	8
Data size	8 Byte	16 Byte
Signal type	Thermocouple	
Signal type	E(-30~900°C), J(-210~1200°C) T(-270~400°C), K(-30~1370°C)	
Cold End compensation	Internal and external (accuracy ≤3K)	
Diagnosis	Yes	
Temperature coefficient	≤ 50 ppm/K	
Connection type	2-line	
Reverse protection	Yes	
Isolation method	Magnetic isolation	
Fault diagnosis	Yes	
Internal Resistance	/	
Resolution	16bit, 0.1°C/ resolution	
Frequency interference suppression	10Hz 50Hz 60Hz 400Hz	
Diagnosis	Disconnection, Parameter assignment error	
Process alarm	Upper/Lower limit, per channel	
Temperature coefficient	±0.5%	
Measuring range	-270°C ~ 1370°C	
Precision	± 0.3%	
Conversion time	125ms	

Temperature module



Product

DF20-M-4TC-KETJ

DF20-M-8TC-KETJ

Power Supply Parameters

Connection type Spring terminal blocks

Working voltage 24V DC +20 %/ -15 %

System feed current <70mA

<100mA

 Maximum area of wire 2.5mm²

 1.5mm²

Maximum area of wire (AWG) AWG14

AWG16

 The minimum area of a wire 0.2mm²

 0.2mm²

The minimum area of a wire (AWG) AWG28

AWG28

Strip length 8...9mm

8...9mm

Mechanical Structure

Protection grade IP20

Size(H X W X D) 100mm X 12mm X 69mm

Installation type 35mm DIN

Work Environment

Working temperature -25...60°C

Storage temperature -40...85°C

Relative humidity 5... 95%RH(non-condensing)

LED Status Indicator

LED1 Green : Power is working

LED2 Green blinks : I/O system and modules working properly

Wiring Diagram

Pin	Description
1	Signal1 +
2	Signal1 -
3	Signal2 +
4	Signal2 -
5	Signal3 +
6	Signal3 -
7	Signal4 +
8	Signal4 -

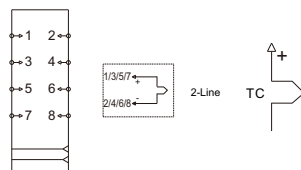

DF20-M-4TC-KETJ

Pin	Description	Pin	Description
1	Signal1 +	9	Signal5 +
2	Signal1 -	10	Signal5 -
3	Signal2 +	11	Signal6 +
4	Signal2 -	12	Signal6 -
5	Signal3 +	13	Signal7 +
6	Signal3 -	14	Signal7 -
7	Signal4 +	15	Signal8 +
8	Signal4 -	16	Signal8 -

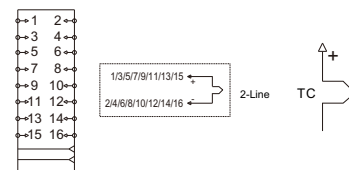

DF20-M-8TC-KETJ

Analog input module

DF20-M-1CNT-EL-4

 Encoder input module,
1 port,24V

DF20-M-1CNT-EL-5

 Encoder input module,
1 port,5V

DF20-M-1CNT-ELP-5

 Encoder input /pulse
output module, 1 port,5V

DF20-M-2CNT-PIL-4

 Pulse counting module,
2 port,24V

DF20-M-2CNT-PIL-5

 Pulse counting module,
2 port,5V

Specification

Product	DF20-M-1CNT-EL-4	DF20-M-1CNT-EL-5	DF20-M-1CNT-ELP-5	DF20-M-2CNT-PIL-4	DF20-M-2CNT-PIL-5
Maximum frequency count	1Mhz	1Mhz	1Mhz	1Mhz	1Mhz
Number of channels	1			2	
Data size	12 Byte			28 Byte	
Input signal type	Incremental encoder			Pulse signal	
Input signal type	24V DC	5V DC	5V DC	24V DC	5V DC
Input connection type	4-line			2-line	
Output signal type	/	/	422 type	/	
Reverse protection	Yes				
Isolation method	Magnetic isolation				
Fault diagnosis	Yes				
Resolution	32 Bit				
Precision	±1 pulse				

Power Supply Parameters

Connection type	Spring terminal blocks				
System feed current	<30mA	<30mA	<200mA	<30mA	<30mA
Maximum area of wire	2.5mm ²				
Maximum area of wire (AWG)	AWG14				
The minimum area of a wire	0.2mm ²				
The minimum area of a wire (AWG)	AWG28				
Strip length	8...9mm				

Analog input module



Product	DF20-M-1CNT-EL-4	DF20-M-1CNT-EL-5	DF20-M-1CNT-ELP-5	DF20-M-2CNT-PIL-4	DF20-M-2CNT-PIL-5
---------	------------------	------------------	-------------------	-------------------	-------------------

Mechanical Structure

Protection grade	IP20				
Size(H X W X D)	100mm X 12mm X 69mm				
Installation type	35mm DIN				

Work Environment

Working temperature	-25...60°C				
Storage temperature	-40...85°C				
Relative humidity	5... 95%RH(non-condensing)				

LED Status Indicator

LED1	Green : Power is working				
LED2	Green blinks : I/O system and modules working properly				

Wiring Diagram

Pin	Description	Notes
1	24V	NPN:1=24V,2=signal
2	0V	PNP:1=signal,2=0V...
3	ENCA+ / ENCA	
4	ENCA- / 0V	
5	ENCB+ / ENCB	
6	ENCB- / 0V	
7	PE	
8	PE	

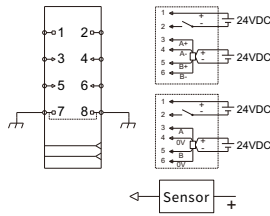

DF20-M-1CNT-EL-4

Pin	Description	Notes
1	24V	NPN:1=24V,2=signal
2	0V	PNP:1=signal,2=0V...
3	ENCA+ / ENCA	
4	ENCA- / 0V	
5	ENCB+ / ENCB	
6	ENCB- / 0V	
7	PE	
8	PE	

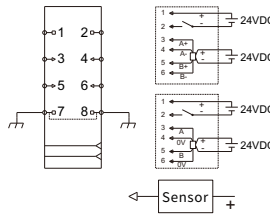

DF20-M-1CNT-EL-5

Pin	Description	Notes
1	24V	NPN:1=24V,2=signal
2	0V	PNP:1=signal,2=0V...
3	ENCA+ / ENCA	
4	ENCA- / 0V	
5	ENCB+ / ENCB	
6	ENCB- / 0V	
7	RS422_TR_out+	
8	RS422_TR_out-	

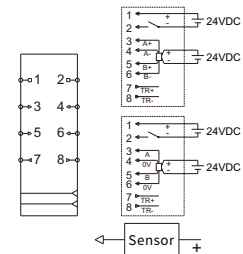

DF20-M-1CNT-ELP-5

Pin	Description	Notes
1	24V	NPN:1=24V,2=signal
2	0V	PNP:1=signal,2=0V...
3	Signal1_24V	
4	Signal1	
5	24V	NPN:5=24V,6=signal
6	0V	PNP:5=signal,6=0V...
7	Signal2_24V	
8	Signal2	

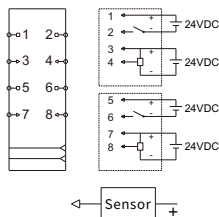

DF20-M-2CNT-PIL-4

Pin	Description	Notes
1	24V	NPN:1=24V,2=signal
2	0V	PNP:1=signal,2=0V...
3	Signal1_24V	
4	Signal1	
5	24V	NPN:5=24V,6=signal
6	0V	PNP:5=signal,6=0V...
7	Signal2_24V	
8	Signal2	

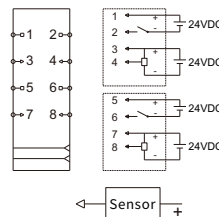

DF20-M-2CNT-PIL-5

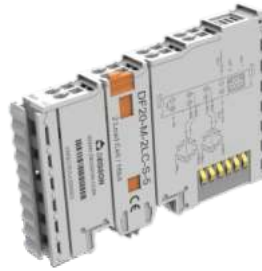

DF20-M-2LC-S-5

Bridge measurement module, 16-bit resolution, 2-channel

Specification

Product	DF20-M-2LC-S-5
Measuring range	0-10mV
Number of channels	2
Signal type	Load Cell Bridge, pressure sensor, Load Cell
Connection type	4-line
Reverse protection	Yes
Isolation method	Magnetic isolation
Data size	8 Byte
Fault diagnosis	Yes
Internal Resistance	>500KΩ
Resolution 16bit	16bit
Frequency interference suppression	10Hz 50Hz 60Hz 400Hz
Diagnosis	Parameter assignment error
Precision	0.20%
Measuring range	-32768~32767
Conversion time	3.3ms

Power Supply Parameters

Connection type	Spring terminal blocks
Working voltage	24V DC +20 %/ -15 %
System feed current	<210mA
Maximum area of wire	2.5mm ²
Maximum area of wire (AWG)	AWG14
The minimum area of a wire	0.2mm ²
The minimum area of a wire (AWG)	AWG28
Strip length	8...9mm

Bridge Module

RoHS

 Product **DF20-M-2LC-S-5**
Mechanical Structure

 Protection grade **IP20**
 Size(H X W X D) **100mm X 12mm X 69mm**
 Installation type **35mm DIN**
Work Environment

 Working temperature **-25...60°C**
 Storage temperature **-40...85°C**
 Relative humidity **5... 95%RH(non-condensing)**
LED Status Indicator

 LED1 **Green: Power is working**
 LED2 **Green blinks: I/O system and modules working properly**
Wiring Diagram

Pin	Description
1	Ref power 5V
2	Ref power 0V
3	Signal1 +
4	Signal1 -
5	Signal2 +
6	Signal2 -
7	PE
8	PE

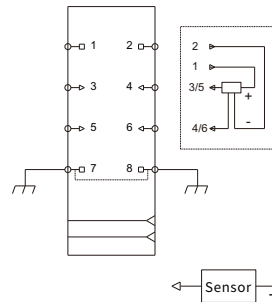
DF20-M-2LC-S-5

Voltage distribution module

DF20-M-DC-U-5

 Voltage distribution module,
24VDC to 5VDC

DF20-M-DC-U-24

 Voltage distribution module,
16 channel 24VDC

DF20-M-DC-U-0

 Voltage distribution module,
16 channel 0VDC

DF20-M-T-8L

 Extended module,
8channel, 2 line

DF20-M-DC-UD-5

 Voltage distribution module,
24VDC to 5VDC

Specification

Product	DF20-M-DC-U-5	DF20-M-DC-U-24	DF20-M-DC-U-0	DF20-M-T-8L	DF20-M-DC-UD-5
Number of channels	1	16	16	8	1
Isolation method	Electrical isolation	/	/	/	/

Power Supply Parameters

Connection type	Spring terminal blocks	Spring terminal blocks	Spring terminal blocks	Spring terminal blocks	Spring terminal blocks
Working voltage	24V DC +20 %/ -15 %	24V DC +20 %/ -15 %	0V DC	0V...36VDC	24V DC +20 %/ -15 %
Reverse power protection	YES		/		YES
Supply system voltage	5VDC		/		5VDC
Supply system current	Max.0.75A		/		Max.2A
Supply load voltage	24V DC +20 %/ -15 %	24V DC +20 %/ -15 %	0VDC	Voltage distribution	24V DC +20 %/ -15 %
Supply load current (MAX)	5A		5A		8A
Maximum area of wire	2.5mm ²		1.5mm ²		2.5mm ²
Maximum area of wire (AWG)	AWG14		AWG16		AWG14
The minimum area of a wire	0.2mm ²		0.2mm ²		0.2mm ²
The minimum area of a wire (AWG)	AWG28		AWG28		AWG28
Strip length	8...9mm		8...9mm		8...9mm

Voltage distribution module

Product	DF20-M-DC-U-5	DF20-M-DC-U-24	DF20-M-DC-U-0	DF20-M-T-8L	DF20-M-DC-UD-5
---------	---------------	----------------	---------------	-------------	----------------

Mechanical Structure

Protection grade	IP20
Size(H X W X D)	100mm X 12mm X 69mm
Installation type	35mm DIN

Work Environment

Working temperature	-25...60°C
Storage temperature	-40...85°C
Relative humidity	5... 95%RH(non-condensing)

LED Status Indicator

POWER-1, POWER-2	Green: The system power is working.	/	Green: The system power is working.
POWER-7, POWER-8	Green: The load power is working.	/	Green: The load power is working.

Wiring Diagram

Pin	Description
1	System_24V
2	System_0V
3	Load_24V
4	Load_24V
5	Load_0V
6	Load_0V
7	PE
8	PE

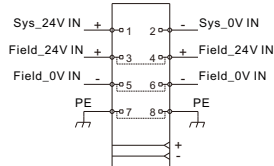

DF20-M-DC-U-5

Pin	Description	Pin	Description
1	Load_24V	9	Load_24V
2	Load_24V	10	Load_24V
3	Load_24V	11	Load_24V
4	Load_24V	12	Load_24V
5	Load_24V	13	Load_24V
6	Load_24V	14	Load_24V
7	Load_24V	15	Load_24V
8	Load_24V	16	Load_24V

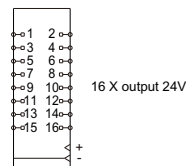

DF20-M-DC-U-24

Pin	Description	Pin	Description
1	Load_0V	9	Load_0V
2	Load_0V	10	Load_0V
3	Load_0V	11	Load_0V
4	Load_0V	12	Load_0V
5	Load_0V	13	Load_0V
6	Load_0V	14	Load_0V
7	Load_0V	15	Load_0V
8	Load_0V	16	Load_0V

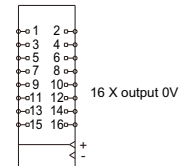

DF20-M-DC-U-0

Pin	Description	Pin	Description
1	Signal1	9	Signal5
2	Signal1	10	Signal5
3	Signal2	11	Signal6
4	Signal2	12	Signal6
5	Signal3	13	Signal7
6	Signal3	14	Signal7
7	Signal4	15	Signal8
8	Signal4	16	Signal8

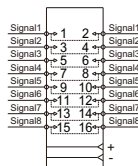

DF20-M-T-8L

Pin	Description
1	System_24V
2	System_0V
3	Load_24V
4	Load_24V
5	Load_0V
6	Load_0V
7	PE
8	PE

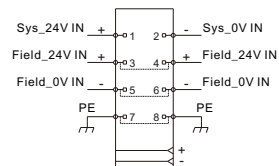

DF20-M-DC-UD-5

DF20-M-1COM-232/485/422

Serial communication module, 1 channel

Specification

Product	DF20-M-1COM-232/485/422
Interface	RS232/RS485/RS422
Number of channels	1
Agreement	Modbus RTU/ASCII master and slave modes; Free protocol transparent mode
BAUD	2400bps - 500000bps
Data bits	7bit/8bit
Check bit	None/Even/Odd/Space/Mark
Stop bit	1bit/2bit
Maximum data frame length	128 byte

Power Supply Parameters

Connection type	Spring terminal blocks
System feed current	<100mA
Maximum area of wire	1.5mm ²
Maximum area of wire (AWG)	AWG16
The minimum area of a wire	0.14mm ²
The minimum area of a wire (AWG)	AWG26
Strip length	8...10mm

Mechanical Structure

Protection grade	IP20
Size(H X W X D)	111mm X 12mm X 75mm
Installation type	35mm DIN

Serial communication module



Product	DF20-M-1COM-232/485/422
Work Environment	
Working temperature	-25...60°C
Storage temperature	-40...85°C
Relative humidity	5... 95%RH(non-condensing)
LED Status Indicator	
PW	Green: Internal bus power supply is normal
ST	Power on stage: green on: module initialization abnormal, green off: module initialization normal
	Operation phase: Green flashing: The internal bus of the module is working normally, green off: The internal bus of the module is working abnormally
COM	On: Input signal valid Off: Input signal invalid
MST	On: Input signal valid Off: Input signal invalid
SLV	On: Input signal valid Off: Input signal invalid
232	In 232 mode, on: connection normal off: connection abnormal
485	In 485 mode, on: connection normal off: connection abnormal
422	In 422 mode, on: connection normal off: connection abnormal
TS	On: Normal communication transmission Off: Abnormal communication transmission
RX	On: normal communication reception Off: abnormal communication reception
EP	On: External power supply normal Off: External power supply normal

Wiring Diagram

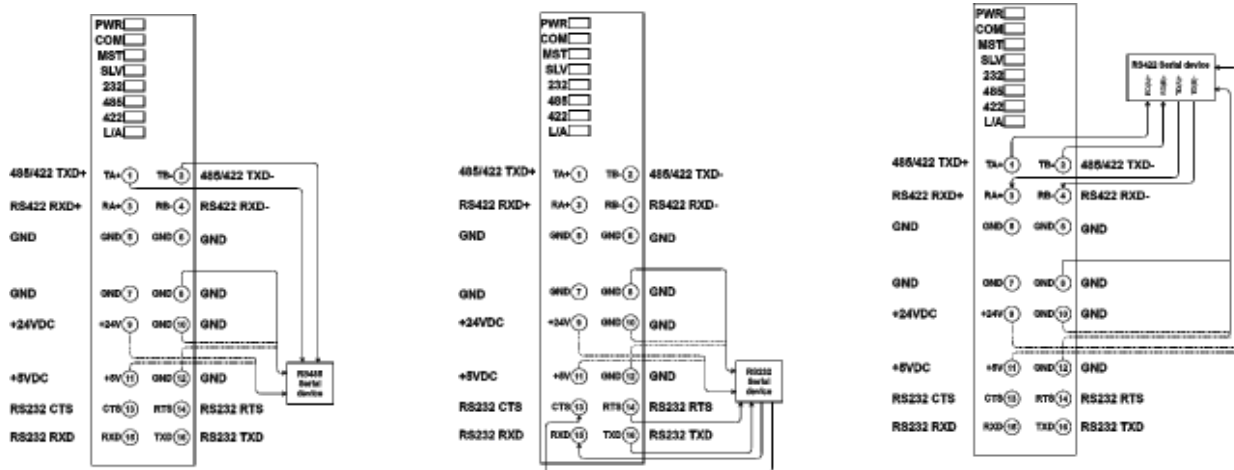

Pin	1	2	3	4	5	6	7	8	9	10	11	12	13	14	15	16
RS485	A	B														
RS422	TX+	TX-	RX+	RX-		GND			24V+	GND	5V+	GND				
RS232													CTS	RTS	RXD	TXD

DF20 series dimension

DF20 series bus coupler & Terminal cover dimension

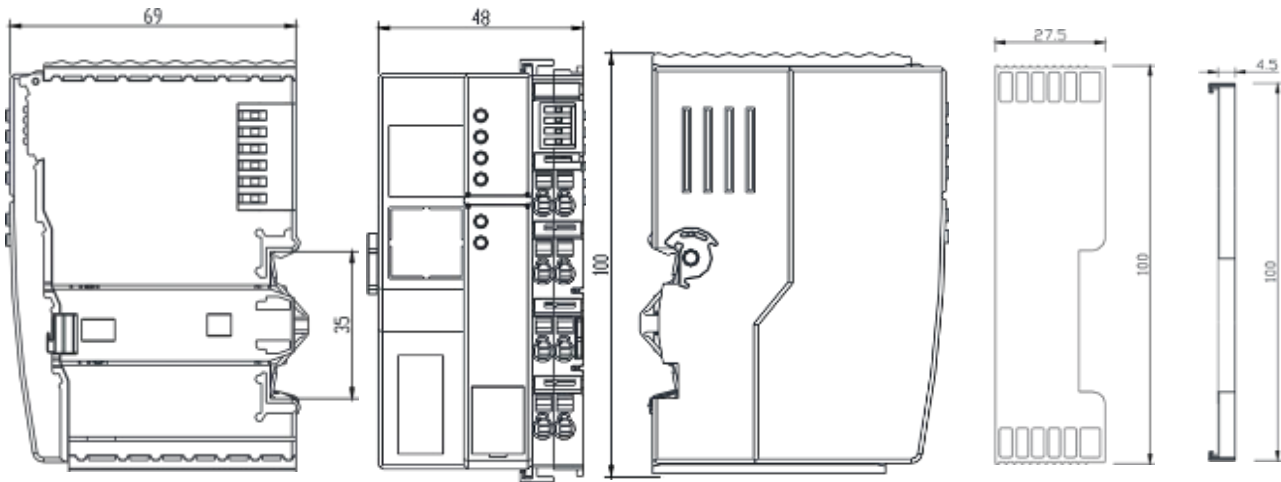

DF20 series I/O module dimension

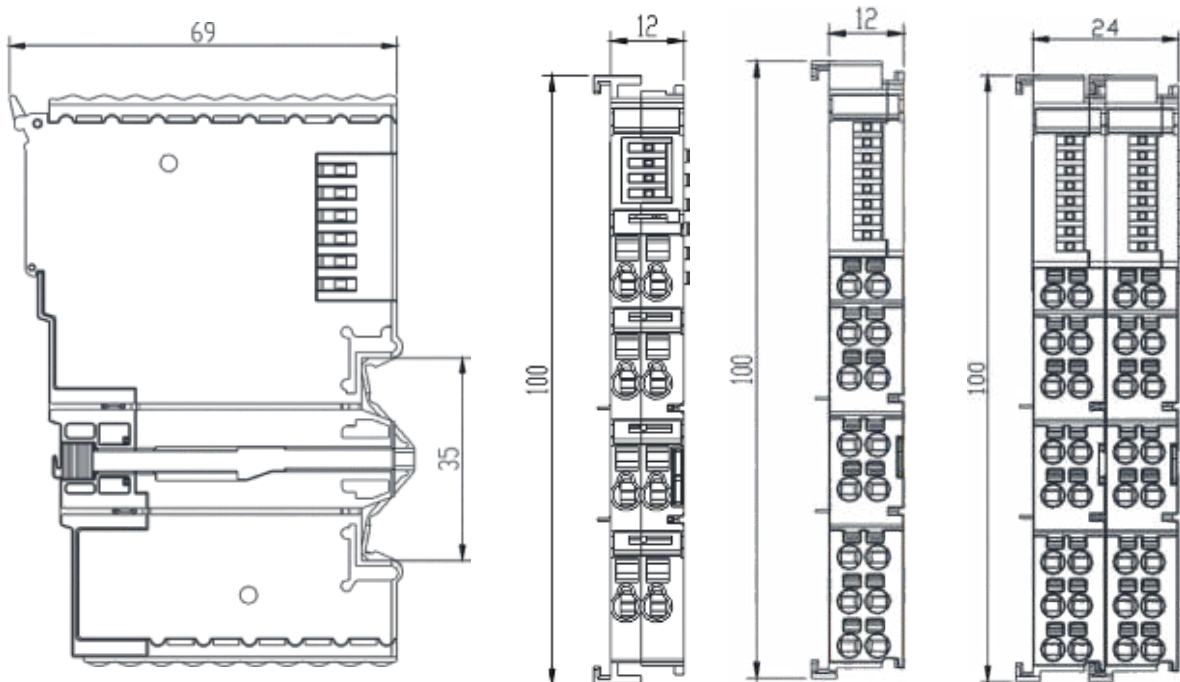

Module with 8 wiring holes

Module with 16 wiring holes

Module with 32 wiring holes

DEGSON Fieldbus High performance IP67 I/O

**Reliable****Robust****Durable**

- Supports multiple mainstream fieldbus protocols
- Flexible and suitable for multiple applications and work environments
- IP67/IP65 high protection structure
- Rich models and I/O types
- Extended Bus Technology (DH Bus) fully isolated, high-speed
- A single fieldbus node can scale up to 512DI/512DO/128AI/128AO

Application Extension Graph

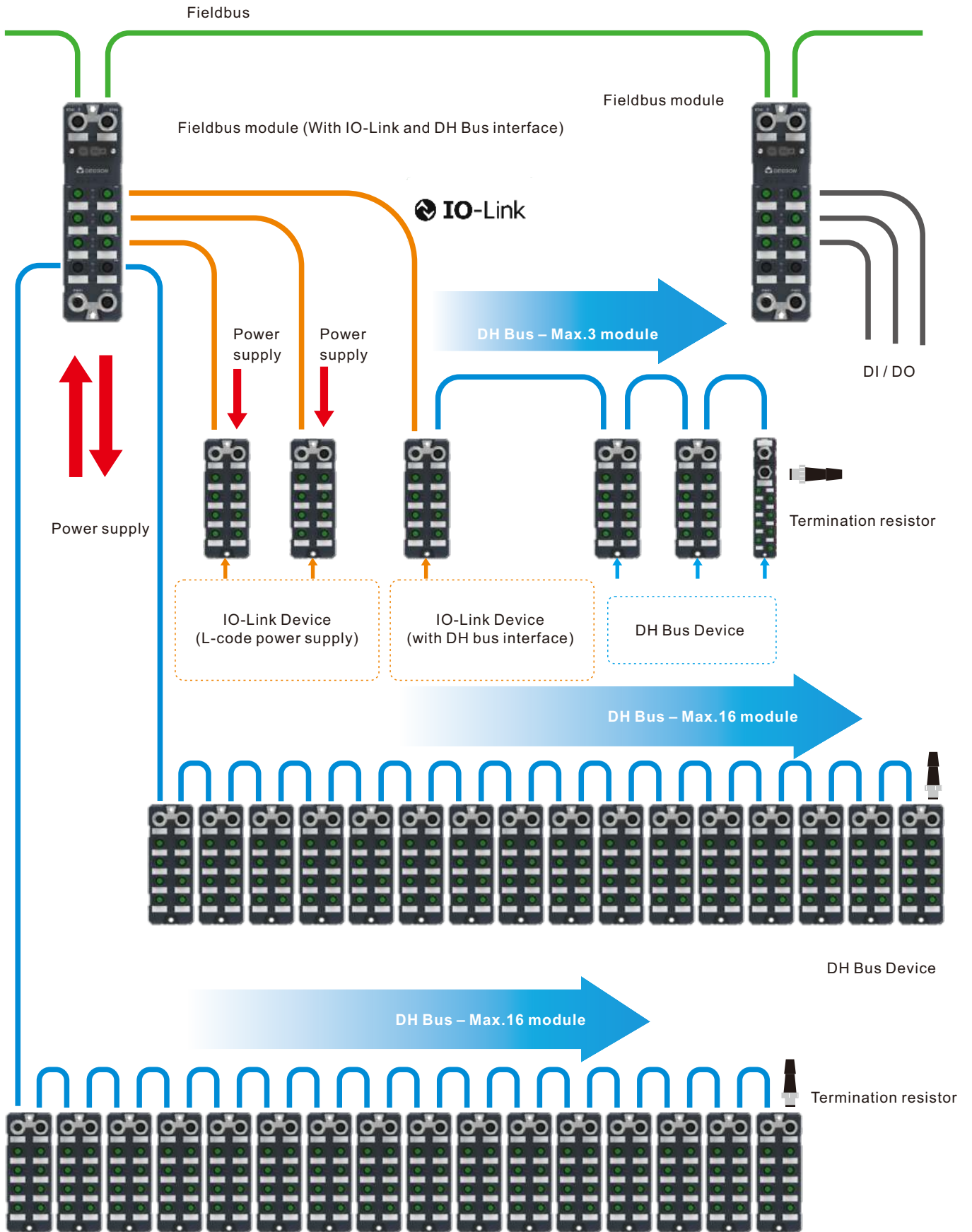

IO-Link



Universal



Smart



Easy

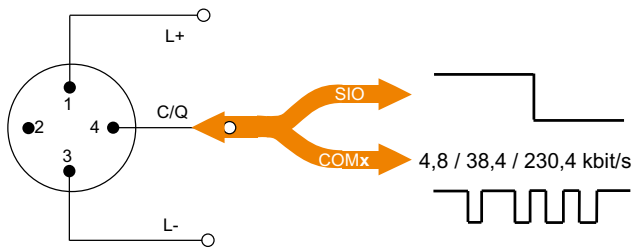

Pin layout: IEC 60947-5-2

Pin	Signal	Definition	Standard
1	L+	24 V	IEC 61131-2
2	I/Q	Not connected, DI, or DO	IEC 61131-2
3	L-	0 V	IEC 61131-2
4	Q	"Switching signal" (SIO)	IEC 61131-2
	C	"Coded switching" (COM1, COM2, COM3)	IEC 61131-9

- IO-Link is the world's first standardized I/O technology for communication with sensors and actuators (IEC 61131-9)
- No additional requirements for cable materials are required, and the conventional 3-wire connection method can achieve powerful point-to-point communication
- IO-Link is not a fieldbus, but a further development of classic sensor and actuator connection technology

DH Bus

- DEGSON High performance Bus
- DEGSON internal communication protocol for efficient remote extension modules
- DH Bus single link can extend up to 16 modules, with a maximum length of 120m, and adjacent stations with a maximum length of 15m
- The last DH Bus station needs to increase terminal resistance to ensure stable and reliable communication

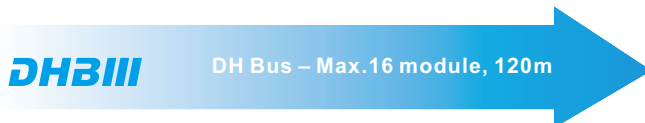

Fieldbus Module

DFH67-PN-IOL2A4B-DHB2-V1

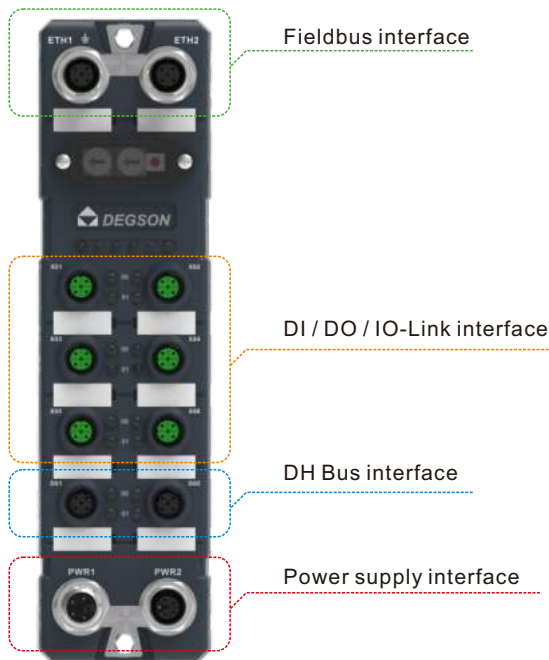
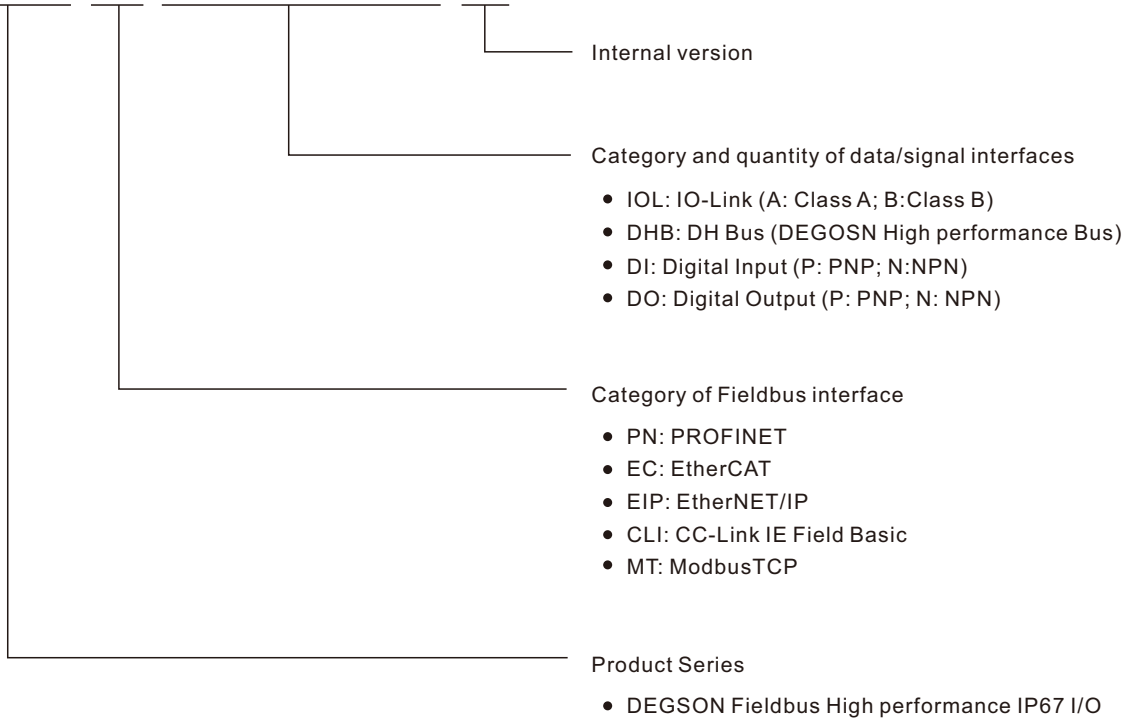

Fieldbus module with DH Bus interface

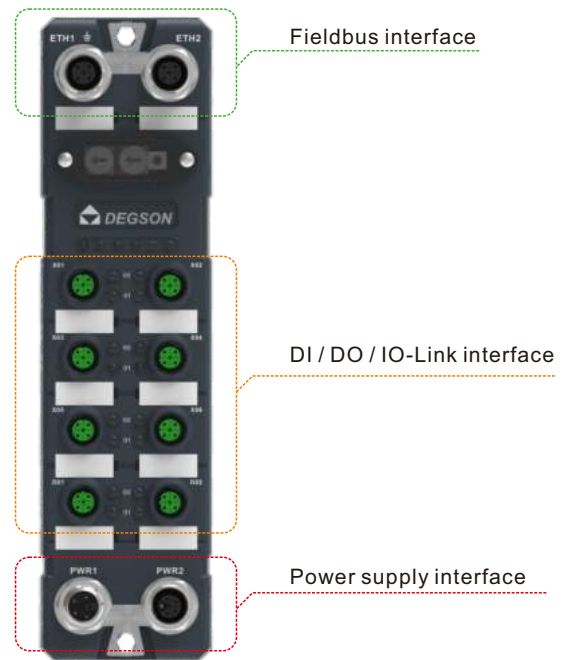

Fieldbus module without DH Bus interface

Fieldbus Module

NO.	Order NO.	Fieldbus interface					Data/Signal interfaces				
		PROFINET	EtherCAT	EtherNET/IP	CC-Link IE	Modbus TCP	IO-Link Class A	IO-Link Class B	DH Bus	DI	DO
1	DFH67-PN-IOL2A4B-DHB2-V1	•					2	4	2	2 PNP	
2	DFH67-PN-IOL6A-DHB2-V1	•					6		2	6 PNP	
3	DFH67-PN-IOL8A-V1	•					8			8 PNP	
4	DFH67-EC-IOL2A4B-DHB2-V1		•				2	4	2	2 PNP	
5	DFH67-EC-IOL6A-DHB2-V1		•				6		2	6 PNP	
6	DFH67-EC-IOL8A-V1		•				8			8 PNP	
7	DFH67-EIP-IOL2A4B-DHB2-V1			•			2	4	2	2 PNP	
8	DFH67-EIP-IOL6A-DHB2-V1			•			6		2	6 PNP	
9	DFH67-EIP-IOL8A-V1			•			8			8 PNP	
10	DFH67-CLI-IOL2A4B-DHB2-V1				•		2	4	2	2 PNP	
11	DFH67-CLI-IOL6A-DHB2-V1				•		6		2	6 PNP	
12	DFH67-CLI-IOL8A-V1				•		8			8 PNP	
13	DFH67-PN-DI12P-DHB2-V1	•							2	12 PNP	
14	DFH67-PN-DI12N-DHB2-V1	•							2	12 NPN	
15	DFH67-EC-DI12P-DHB2-V1		•						2	12 PNP	
16	DFH67-EC-DI12N-DHB2-V1		•						2	12 NPN	
17	DFH67-EIP-DIO12P-DHB2-V1	1*		•					2	12 PNP (Configurable)	
18	DFH67-EIP-DIO12N-DHB2-V1	1*		•					2	12 NPN (Configurable)	
19	DFH67-CLI-DIO12P-DHB2-V1	1*			•				2	12 PNP (Configurable)	
20	DFH67-CLI-DIO12N-DHB2-V1	1*			•				2	12 NPN (Configurable)	
21	DFH67-MT-DIO12P-DHB2-V1	1*				•			2	12 PNP (Configurable)	
22	DFH67-MT-DIO12N-DHB2-V1	1*				•			2	12 NPN (Configurable)	

1*: This model requires less usage and has a longer lead time.

IO-Link module

DFH67-IOLA-DIO16P-M12-V1

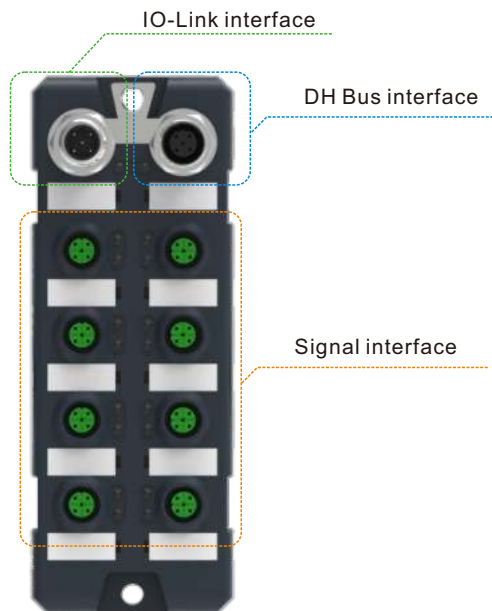
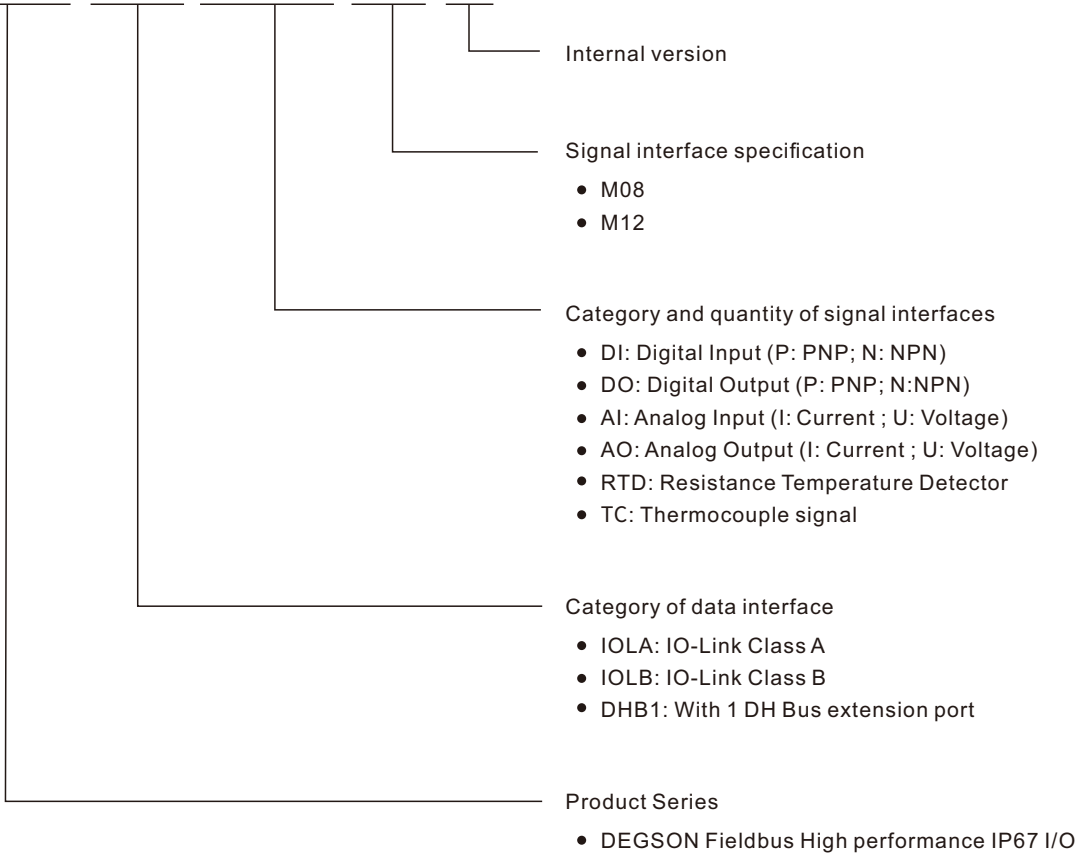

IO-Link module with DH Bus interface

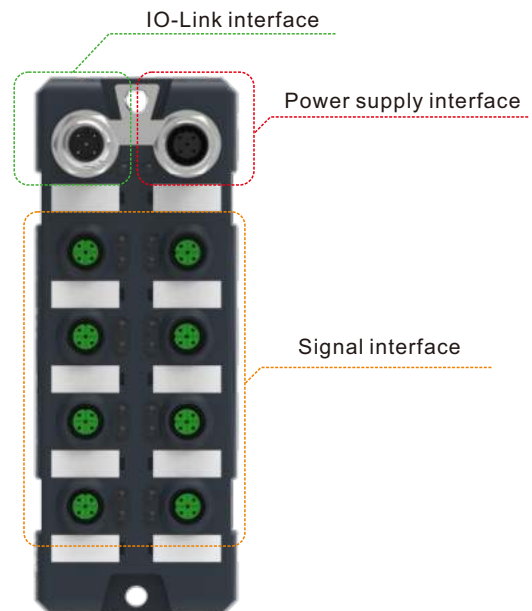

IO-Link module without DH Bus interface

IO-Link module

NO.	Order NO.	Data interfaces			Signal interfaces										
		IO-Link Class A	IO-Link Class B	DH Bus	DI-P	DO-P	DI-N	DO-N	AI-I	AO-I	AI-U	AO-U	RTD	TC	
1	DFH67-IOLA-DIO16P-M12-V1	•			16 (Configurable)										
2	DFH67-IOLA-DIO16N-M12-V1	•					16 (Configurable)								
3	DFH67-IOLA-DHB1-DIO16P-M12-V1	•		1	16 (Configurable)										
4	DFH67-IOLA-DHB1-DIO16N-M12-V1	•		1			16 (Configurable)								
5	DFH67-IOLA-DHB1-AI4I-AO4I-M12-V1	1*	•	1					4	4					
6	DFH67-IOLA-DHB1-AI4U-AO4U-M12-V1	1*	•	1							4	4			
7	DFH67-IOLA-DHB1-AI8I-M12-V1	1*	•	1					8						
8	DFH67-IOLA-DHB1-AI8U-M12-V1	1*	•	1							8				
9	DFH67-IOLA-DHB1-AI4I-M12-V1	1*	•	1					4						
10	DFH67-IOLA-DHB1-AI4U-M12-V1	1*	•	1							4				

1*: This model requires less usage and has a longer lead time.

DH Bus module

DFH67-DHB-DIO16P-M12-V1

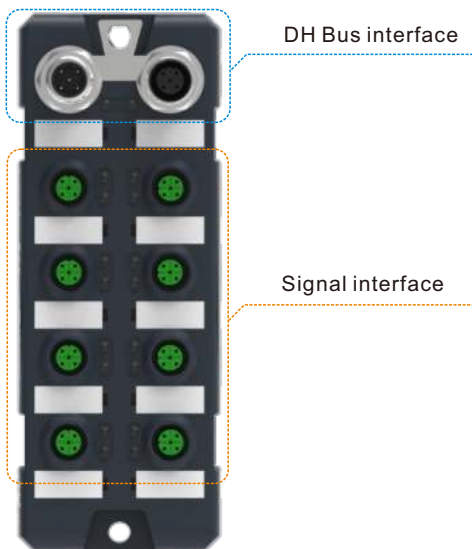
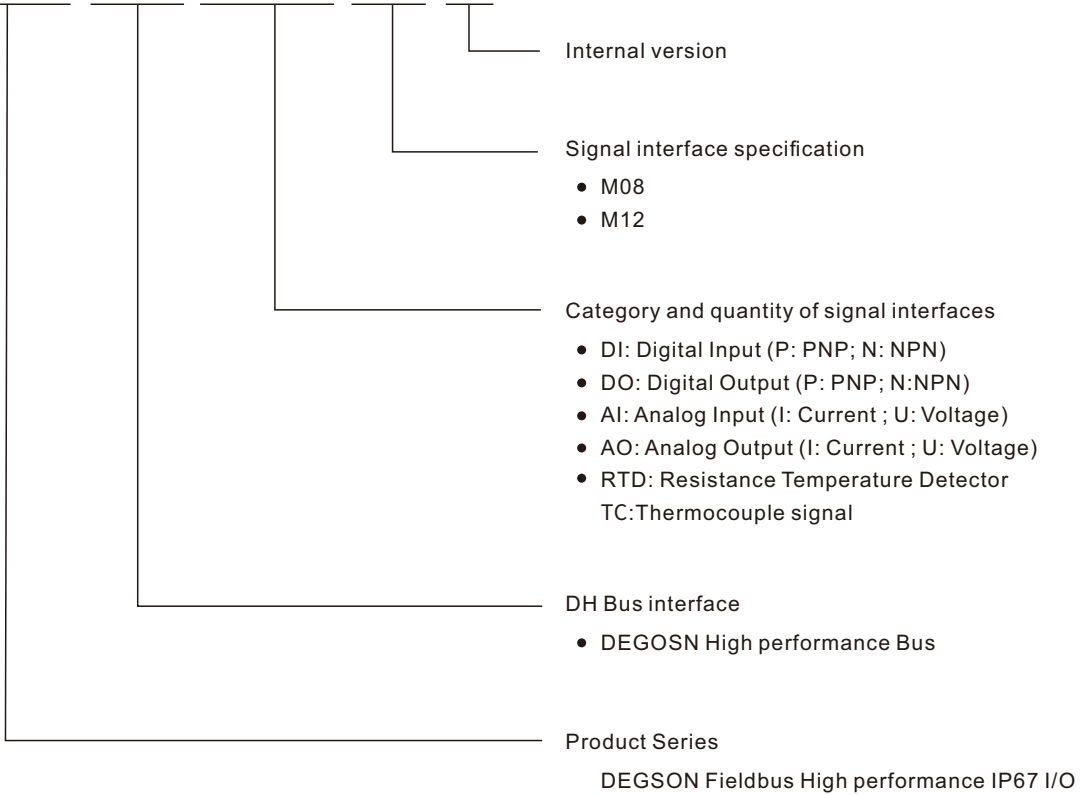

DH Bus module for M12 signal interface

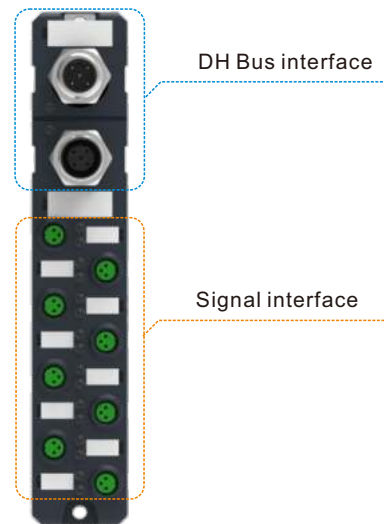

DH Bus module for M8 signal interface

DH Bus module

NO.	Order NO.	Data interfaces			Signal interfaces										
		IO-Link Class A	IO-Link Class B	DH Bus	DI-P	DO-P	DI-N	DO-N	AI-I	AO-I	AI-U	AO-U	RTD	TC	
1	DFH67-DHB-DIO16P-M12-V1			•	16 (Configurable)										
2	DFH67-DHB-DIO16N-M12-V1			•			16 (Configurable)								
3	DFH67-DHB-DI16P-M12-V1			•	16										
4	DFH67-DHB-DI16N-M12-V1			•			16								
5	DFH67-DHB-DI8P-M08-V1			•	8										
6	DFH67-DHB-DI8N-M08-V1			•			8								
7	DFH67-DHB-DO16P-M12-V1			•		16									
8	DFH67-DHB-DO16N-M12-V1			•			16								
9	DFH67-DHB-DO8P-M08-V1			•		8									
10	DFH67-DHB-DO8N-M08-V1			•			8								
11	DFH67-DHB-DI8P-DO8P-M12-V1			•	8	8									
12	DFH67-DHB-DI8N-DO8N-M12-V1			•			8	8							
13	DFH67-DHB-DI4P-DO4P-M08-V1	1*		•	4	4									
14	DFH67-DHB-DI4N-DO4N-M08-V1	1*		•			4	4							
15	DFH67-DHB-AI8I-M12-V1			•					8						
16	DFH67-DHB-AI8U-M12-V1			•						8					
17	DFH67-DHB-AI4I-M12-V1			•					4						
18	DFH67-DHB-AI4U-M12-V1			•						4					
19	DFH67-DHB-AO4I-AO4U-M12-V1			•					4		4				
20	DFH67-DHB-AO8I-M12-V1	1*		•					8						
21	DFH67-DHB-AO8U-M12-V1	1*		•							8				
22	DFH67-DHB-AO4I-M12-V1	1*		•					4						
23	DFH67-DHB-AO4U-M12-V1	1*		•							4				
24	DFH67-DHB-AI4I-AO4I-M12-V1	1*		•				4	4						
25	DFH67-DHB-AI4U-AO4U-M12-V1	1*		•						4	4				
26	DFH67-DHB-RTD8-M12-V1			•								8			
27	DFH67-DHB-RTD4-M12-V1			•								4			
28	DFH67-DHB-TC8-M12-V1	1*		•									8		
29	DFH67-DHB-TC4-M12-V1	1*		•									4		

1*: This model requires less usage and has a longer lead time.

IO-Link Master

RoHS

Features

- Designed according to IO-Link v1.1 specifications
- IO-Link master supports COM1/COM2/COM3
- IO-Link Interface supports Class-A or Class-B type
- Support DH BUS extension

PROFINET-RT PROTOCOL
Ordering Data

Order No.	DFH67-PN-IOL2A4B-DHB2-V1	DFH67-PN-IOL6A-DHB2-V1	DFH67-PN-IOL8A-V1
Description	PROFINET-RT slave & IO-Link master 2* Class A + 4*Class B 2*DH BUS interface	PROFINET-RT slave & IO-Link master 6* Class A 2*DH BUS interface	PROFINET-RT slave & IO-Link master 8* Class A

Fieldbus

Protocol	PROFINET-RT
Operation mode	Automatic negotiation ; Auto MDI/MDIX
Transmission speed	10/100 Mbps
IP allocation	Programming software configuration, or allocation by master
Topology	Yes
MRP	Yes

Power Supply

Working voltage	24 VDC (18...30 VDC)
Current consumption	Max. 200mA
System and Input	Us , Max. 8A
Actuators	Ua , Max. 8A
Electrical isolation	Us/Ua : 24V isolated , 0V isolation

Interface Type

Power supply	2 * L-code 5pin , Plug(input) + Socket(output)	
Fieldbus	2 * M12 D-code 4pin , Socket	
Signal	6 * M12 A-code 5pin , Socket	8 * M12 A-code 5pin , Socket
DH Bus interface	2 * M12 B-code 5pin , Socket	/
Number of DH Bus modules	Max. 32 (16 × 2)	/
Extension distance of DH Bus	Single chain path: Max. 120m; Between adjacent modules: Max. 15m	/

Electrical Parameters

IO-Link channels	6	6	8
Interface type	2*Class-A + 4*Class-B	6*Class-A	8*Class-A
IO-Link version	IO-Link V1.1		
Transmission speed	COM1 (4.8kbps) , COM2 (38.4kbps) , COM3 (230.4kbps)		

IO-Link Master

RoHS
Ordering Data

Order No.	DFH67-PN-IOL2A4B-DHB2-V1	DFH67-PN-IOL6A-DHB2-V1	DFH67-PN-IOL8A-V1
-----------	--------------------------	------------------------	-------------------

Electrical parameters

Signal type	DI/DO/IO-Link Configurable by software		
Number of inputs	Max. 8	Max. 12	Max. 16
Us current (Pin1&Pin3)	IO-Link interface : Max. 1.6A ; Signal interface: Max. 200mA		
Ua current (Pin2&Pin5)	Per channel : Max. 2A	/	
Input signal type	PNP type		
Input filter time	Max. 1.6ms		
Number of outputs	Max. 6	Max. 6	Max. 8
Output current	Per channel : Max. 2A		
Output signal type	PNP/NPN type(configurable)		
Output switch frequency	Resistive load : 100Hz ; Inductive load : 5Hz		

Diagnostic

Communication Status	LED indication, Communication message
Power supply	Yes, Low voltage alarm
Short circuit/Overload	Yes, LED indication

General data

Degree of protection	IP67
Temperature range	Operation temperature : -20~60 °C ; Storage temperature : -40~85 °C
Installation	2-hole fixing

IO-Link Master

RoHS

Features

- Designed according to IO-Link v1.1 specifications
- IO-Link master supports COM1/COM2/COM3
- IO-Link Interface supports Class-A or Class-B type
- Support DH BUS extension

EtherCAT PROTOCOL
Ordering Data

Order No.	DFH67-EC-IOL2A4B-DHB2-V1	DFH67-EC-IOL6A-DHB2-V1	DFH67-EC-IOL8A-V1
Description	EtherCAT slave & IO-Link master 2* Class A + 4*Class B 2*DH BUS interface	EtherCAT slave & IO-Link master 6* Class A 2*DH BUS interface	EtherCAT slave & IO-Link master 8* Class A

Fieldbus

Protocol	EtherCAT
Operation mode	Automatic negotiation ; Auto MDI/MDIX
Transmission speed	10/100 Mbps
IP allocation	System automatic allocation or DIP switch setting
Topology	Yes

Power Supply

Working voltage	24 VDC (18...30 VDC)
Current consumption	Max. 200mA
System and Input	Us , Max. 8A
Actuators	Ua , Max. 8A
Electrical isolation	Us/Ua : 24V isolated , 0V isolation

Interface Type

Power supply	2 * L-code 5pin , Plug(input) + Socket(output)	
Fieldbus	2 * M12 D-code 4pin , Socket	
Signal	6 * M12 A-code 5pin , Socket	8 * M12 A-code 5pin , Socket
DH Bus interface	2 * M12 B-code 5pin , Socket	/
Number of DH Bus modules	Max. 32 (16 × 2)	/
Extension distance of DH Bus	Single chain path: Max. 120m; Between adjacent modules: Max. 15m	/

Electrical Parameters

IO-Link channels	6	6	8
Interface type	2*Class-A + 4*Class-B	6*Class-A	8*Class-A
IO-Link version	IO-Link V1.1		
Transmission speed	COM1 (4.8kbps) , COM2 (38.4kbps) , COM3 (230.4kbps)		

IO-Link Master

RoHS
Ordering Data

Order No.	DFH67-EC-IOL2A4B-DHB2-V1	DFH67-EC-IOL6A-DHB2-V1	DFH67-EC-IOL8A-V1
-----------	--------------------------	------------------------	-------------------

Electrical parameters

Signal type	DI/DO/IO-Link Configurable by software		
Number of inputs	Max. 8	Max. 12	Max. 16
Us current (Pin1&Pin3)	IO-Link interface : Max. 1.6A ; Signal interface: Max. 200mA		
Ua current (Pin2&Pin5)	Per channel : Max. 2A	/	
Input signal type	PNP type		
Input filter time	Max. 1.6ms		
Number of outputs	Max. 6	Max. 6	Max. 8
Output current	Per channel : Max. 2A		
Output signal type	PNP/NPN type(configurable)		
Output switch frequency	Resistive load : 100Hz ; Inductive load : 5Hz		

Diagnostic

Communication Status	LED indication, Communication message
Power supply	Yes, Low voltage alarm
Short circuit/Overload	Yes, LED indication

General data

Degree of protection	IP67
Temperature range	Operation temperature : -20~60 °C ; Storage temperature : -40~85 °C
Installation	2-hole fixing

IO-Link Master

RoHS

**CC-Link IE Field
Basic PROTOCOL**
Features

- Designed according to IO-Link v1.1 specifications
- IO-Link master supports COM1/COM2/COM3
- IO-Link Interface supports Class-A or Class-B type
- Support DH BUS extension

Ordering Data

Order No.	DFH67-CLI-HOL2A4B-DHB2-V1	DFH67-CLI-HOL6A-DHB2-V1	DFH67-CLI-HOL8A-V1
Description	CC-Link IEFB slave & IO-Link master 2* Class A + 4*Class B 2*DH BUS interface	CC-Link IEFB slave & IO-Link master 6* Class A 2*DH BUS interface	CC-Link IEFB slave & IO-Link master 8* Class A

Fieldbus

Protocol	CC-Link IE Field Basic
Operation mode	Remote device station
Transmission speed	10/100 Mbps
IP allocation	Web server configuration or DIP switch setting
Topology	Yes

Power Supply

Working voltage	24 VDC (18...30 VDC)
Current consumption	Max. 200mA
System and Input	Us , Max. 8A
Actuators	Ua , Max. 8A
Electrical isolation	Us/Ua : 24V isolated , 0V isolation

Interface Type

Power supply	2 * L-code 5pin , Plug(input) + Socket(output)	
Fieldbus	2 * M12 D-code 4pin , Socket	
Signal	6 * M12 A-code 5pin , Socket	8 * M12 A-code 5pin , Socket
DH Bus interface	2 * M12 B-code 5pin , Socket	/
Number of DH Bus modules	Max. 32 (16 × 2)	/
Extension distance of DH Bus	Single chain path: Max. 120m; Between adjacent modules: Max. 15m	/

Electrical Parameters

IO-Link channels	6	6	8
Interface type	2*Class-A + 4*Class-B	6*Class-A	8*Class-A
IO-Link version	IO-Link V1.1		
Transmission speed	COM1 (4.8kbps) , COM2 (38.4kbps) , COM3 (230.4kbps)		

IO-Link Master

RoHS
Ordering Data

Order No.	DFH67-CLI-IOL2A4B-DHB2-V1	DFH67-CLI-IOL6A-DHB2-V1	DFH67-CLI-IOL8A-V1
-----------	---------------------------	-------------------------	--------------------

Electrical parameters

Signal type	DI/DO/IO-Link Configurable by software		
Number of inputs	Max. 8	Max. 12	Max. 16
Us current (Pin1&Pin3)	IO-Link interface : Max. 1.6A ; Signal interface: Max. 200mA		
Ua current (Pin2&Pin5)	Per channel : Max. 2A	/	
Input signal type	PNP type		
Input filter time	Max. 1.6ms		
Number of outputs	Max. 6	Max. 6	Max. 8
Output current	Per channel : Max. 2A		
Output signal type	PNP/NPN type(configurable)		
Output switch frequency	Resistive load : 100Hz ; Inductive load : 5Hz		

Diagnostic

Communication Status	LED indication, Communication message
Power supply	Yes, Low voltage alarm
Short circuit/Overload	Yes, LED indication

General data

Degree of protection	IP67
Temperature range	Operation temperature : -20~60 °C ; Storage temperature : -40~85 °C
Installation	2-hole fixing

IO-Link Master

RoHS

EtherNet/IP PROTOCOL
Features

- Designed according to IO-Link v1.1 specifications
- IO-Link master supports COM1/COM2/COM3
- IO-Link Interface supports Class-A or Class-B type
- Support DH BUS extension

Ordering Data

Order No.	DFH67-EIP-IOL2A4B-DHB2-V1	DFH67-EIP-IOL6A-DHB2-V1	DFH67-EIP-IOL8A-V1
Description	EtherNet/IP slave & IO-Link master 2* Class A + 4*Class B 2*DH BUS interface	EtherNet/IP slave & IO-Link master 6* Class A 2*DH BUS interface	EtherNet/IP slave & IO-Link master 8* Class A

Fieldbus

Protocol	EtherNet/IP
Operation mode	Automatic negotiation ; Auto MDI/MDIX
Transmission speed	10/100 Mbps
IP allocation	Web server configuration or DIP switch setting
Topology	Yes

Power Supply

Working voltage	24 VDC (18...30 VDC)
Current consumption	Max. 200mA
System and Input	Us , Max. 8A
Actuators	Ua , Max. 8A
Electrical isolation	Us/Ua : 24V isolated , 0V isolation

Interface Type

Power supply	2 * L-code 5pin , Plug(input) + Socket(output)	
Fieldbus	2 * M12 D-code 4pin , Socket	
Signal	6 * M12 A-code 5pin , Socket	8 * M12 A-code 5pin , Socket
DH Bus interface	2 * M12 B-code 5pin , Socket	/
Number of DH Bus modules	Max. 32 (16 × 2)	/
Extension distance of DH Bus	Single chain path: Max. 120m; Between adjacent modules: Max. 15m	/

Electrical Parameters

IO-Link channels	6	6	8
Interface type	2*Class-A + 4*Class-B	6*Class-A	8*Class-A
IO-Link version	IO-Link V1.1		
Transmission speed	COM1 (4.8kbps) , COM2 (38.4kbps) , COM3 (230.4kbps)		

IO-Link Master

RoHS
Ordering Data

Order No.	DFH67-EIP-IOL2A4B-DHB2-V1	DFH67-EIP-IOL6A-DHB2-V1	DFH67-EIP-IOL8A-V1
-----------	---------------------------	-------------------------	--------------------

Electrical parameters

Signal type	DI/DO/IO-Link Configurable by software		
Number of inputs	Max. 8	Max. 12	Max. 16
Us current (Pin1&Pin3)	IO-Link interface : Max. 1.6A ; Signal interface: Max. 200mA		
Ua current (Pin2&Pin5)	Per channel : Max. 2A	/	
Input signal type	PNP type		
Input filter time	Max. 1.6ms		
Number of outputs	Max. 6	Max. 6	Max. 8
Output current	Per channel : Max. 2A		
Output signal type	PNP/NPN type(configurable)		
Output switch frequency	Resistive load : 100Hz ; Inductive load : 5Hz		

Diagnostic

Communication Status	LED indication, Communication message
Power supply	Yes, Low voltage alarm
Short circuit/Overload	Yes, LED indication

General data

Degree of protection	IP67
Temperature range	Operation temperature : -20~60 °C ; Storage temperature : -40~85 °C
Installation	2-hole fixing

IO-Link Master



Dimension

M12-MASTER

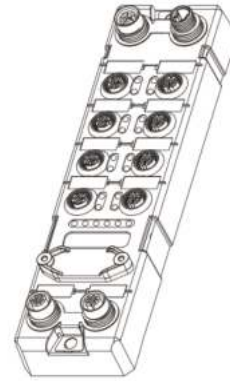
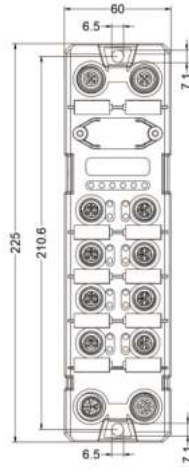

Power supply interface

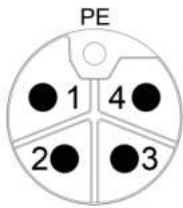

Power supply L-code plug (Metal) - PWR1

- 1-System and signal power supply Us+
- 2-Actuator Power supply Ua-
- 3-System and signal power supply Us-
- 4-Actuator Power supply Ua+
- 5-PE-Protective grounding PE

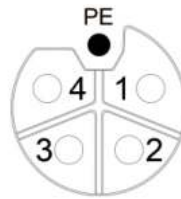

Power supply L-code socket (Metal) - PWR2

Fieldbus & DH BUS interface

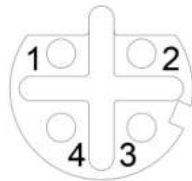

Fieldbus interface D-code socket (Metal) - ETH1/ETH2

- 1-Transmitter Tx+
- 2-Receiver Rx+
- 3-Transmitter Tx-
- 4-Receiver Rx-

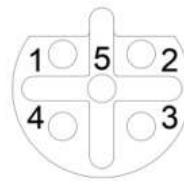

DH Bus B-code socket (Black) - D01/D02

- 1-Power supply 24V+
- 2-Data signal A
- 3-Data signal B
- 4-Power supply GND
- 5-ADR 1

IO-Link interface

M12 A-code socket (Green)

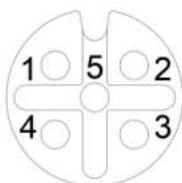

IO-Link Class-A interface (Green)

- 1-Power supply 24V+
- 2-Digital Input/Output
- 3-Power supply GND
- 4-IO-Link C/Q
- 5-Protective grounding PE

IO-Link Class-B interface (Green)

- 1-Power supply 24V+
- 2-Actuator power supply P24
- 3-Power supply GND
- 4-IO-Link C/Q
- 5-Actuator power supply N24

IO-Link digital device



RoHS

Features

- Input/Output photoelectric isolation
- Input or Output configurable
- Overvoltage and short circuit protection function
- Designed according to IO-Link v1.1 specifications ,
Communication rate : COM2

Ordering Data

Order No.	DFH67-IOLA-DHB1-DIO16P-M12-V1	DFH67-IOLA-DHB1-DIO16N-M12-V1
Description	16 DI/DO , PNP , 8*M12	16 DI/DO , NPN , 8*M12

Interface type

IO-Link interface	1 * M12 A-code 4pin Plug	
DH Bus interface	1 * M12 B-code 5pin Socket	
Power	IO Link interface power supply : 24V, 1.6A	
Signal	8 * M12 A-code 5pin , Socket	

Electrical parameters

Supply Voltage	24 VDC (18...30V)	
Current consumption	Max. 50mA	
Number of inputs	Max. 16 , PNP type	Max. 16 , NPN type
Input signal type	Sensor, Limit switch, Contact, etc	
Input filter time	Max. 2ms	
Number of outputs	Max. 16 , PNP type	Max. 16 , NPN type
Output signal type	Actuators, Indicator lights, Mini electromagnetic valves, etc	
Output current	Per channel : Max. 0.3A , Total : Max. 1.5A	
Output switch frequency	Resistive load : 100Hz ; Inductive load : 5Hz	
Extending capability	Up to 3 DH BUS extension modules (up to 1 analog or temperature module) , Total length not exceeding 60m	

IO-Link parameters

Interface type	CLASS A
IO-Link version	IO-Link V1.1
Transmission speed	COM2 (38.4kbps)
Process data	2 input bytes, 2 output bytes

Diagnostic

Communication Status	LED indication, Communication message
Power supply	Yes, Low voltage alarm
Short circuit/Overload	Yes, LED indication

General data

Degree of protection	IP67
Temperature range	Operation temperature : -20-60 °C ; Storage temperature : -40-85 °C
Installation	2-hole fixing

IO-Link digital device



RoHS

Features

- Input/Output photoelectric isolation
- Input or Output configurable
- Overvoltage and short circuit protection function
- Designed according to IO-Link v1.1 specifications ,
Communication rate : COM2

Ordering Data

Order No.	DFH67-IOLA-DIO16P-M12-V1	DFH67-IOLA-DIO16N-M12-V1
Description	16 DI/DO , PNP , 8*M12	16 DI/DO , NPN , 8*M12

Interface type

IO-Link interface	1 * M12 A-code 4pin Plug
Power	1 * M12 L-code 5pin Plug : 24V , 8A
Signal	8 * M12 A-code 5pin , Socket

Electrical parameters

Supply Voltage	24 VDC (18...30V)	
Current consumption	Max. 50mA	
Number of inputs	Max. 16 , PNP type	Max. 16 , NPN type
Input signal type	Sensor, Limit switch, Contact, etc	
Input filter time	Max. 2ms	
Number of outputs	Max. 16 , PNP type	Max. 16 , NPN type
Output signal type	Actuators, Indicator lights, Mini electromagnetic valves, etc	
Output current	Per channel : Max. 0.5A , Total : Max. 8A	
Output switch frequency	Resistive load : 100Hz ; Inductive load : 5Hz	
Extending capability	No	

IO-Link parameters

Interface type	CLASS A
IO-Link version	IO-Link V1.1
Transmission speed	COM2 (38.4kbps)
Process data	2 input bytes, 2 output bytes

Diagnostic

Communication Status	LED indication, Communication message
Power supply	Yes, Low voltage alarm
Short circuit/Overload	Yes, LED indication

General data

Degree of protection	IP67
Temperature range	Operation temperature : -20~60 °C ; Storage temperature : -40~85 °C
Installation	2-hole fixing

Features

- Resolution : 16 bit
- Interface type : Class-A
- Designed according to IO-Link v1.1 specifications ,
Communication rate : COM2

Ordering Data

Order No.	DFH67-IOLA-DHB1-AI4I-AO4I-M12-V1	DFH67-IOLA-DHB1-AI4U-AO4U-M12-V1
Description	4 AI+4AO , Current type , 8*M12	4 AI+4AO , Voltage type , 8*M12

Interface type

IO-Link interface	1 * M12 A-code 4pin Plug	
DH Bus interface	1 * M12 B-code 5pin Socket	
Power	IO Link interface power supply : 24V, 1.6A	
Signal	8 * M12 A-code 5pin , Socket	

Electrical parameters

Supply Voltage	24 VDC (18...30V)	
Current consumption	Max. 50mA	
Number of inputs	4	
Input signal type	4AI (0~20mA , First 4 channels)	4AI (±10V , First 4 channels)
Input impedance	< 450Ω	> 1kΩ
Number of outputs	4	
Output signal type	4AO (0~20mA , Last 4 channels)	4AO (±10V , Last 4 channels)
Resolution	16Bit	
Conversion time	Max. 300us	
Precision	± 0.3%	
Extending capability	Up to 3 DH BUS extension modules (up to 1 analog or temperature module) , Total length not exceeding 60m	

IO-Link parameters

Interface type	CLASS A
IO-Link version	IO-Link V1.1
Transmission speed	COM2 (38.4kbps)
Process data	8 input bytes, 8 output bytes

Diagnostic

Communication Status	LED indication, Communication message
Power supply	Yes, Low voltage alarm
Short circuit/Overload	Yes, LED indication

General data

Degree of protection	IP67
Temperature range	Operation temperature : -20~60 °C ; Storage temperature : -40~85 °C
Installation	2-hole fixing

IO-Link analog device



RoHS

Features

- Designed according to IO-Link v1.1 specifications , Communication rate : COM2
- Interface type : Class-A

Ordering Data

Order No.	DFH67-IOLA-DHB1-AI4I-M12-V1	DFH67-IOLA-DHB1-AI4U-M12-V1	DFH67-IOLA-DHB1-AI8I-M12-V1	DFH67-IOLA-DHB1-AI8U-M12-V1
Description	4 AI , Current type , 8*M12	4 AI , Voltage type , 8*M12	8 AI , Current type , 8*M12	8 AI , Voltage type , 8*M12

Interface type

IO-Link interface	1 * M12 A-code 4pin Plug
DH Bus interface	1 * M12 B-code 5pin Socket
Power	IO Link interface power supply : 24V, 1.6A
Signal	8 * M12 A-code 5pin , Socket

Electrical parameters

Supply Voltage	24 VDC (18...30V)			
Current consumption	Max. 50mA			
Number of inputs	4 (First 4 channels)		8	
Input signal type	0-20mA	±10V	0-20mA	±10V
Input impedance	Current input : 250Ω ; Voltage input : 1MΩ			
Resolution	16Bit			
Conversion time	Max. 300us			
Precision	± 0.3%			
Extending capability	Up to 3 DH BUS extension modules (up to 1 analog or temperature module) , Total length not exceeding 60m			

IO-Link parameters

Interface type	CLASS A		
IO-Link version	IO-Link V1.1		
Transmission speed	COM2 (38.4kbps)		
Process data	8 input bytes		16 input bytes

Diagnostic

Communication Status	LED indication, Communication message
Power supply	Yes, Low voltage alarm
Short circuit/Overload	Yes, LED indication

General data

Degree of protection	IP67
Temperature range	Operation temperature : -20-60 °C ; Storage temperature : -40-85 °C
Installation	2-hole fixing

IO-Link module CE RoHS

Dimension

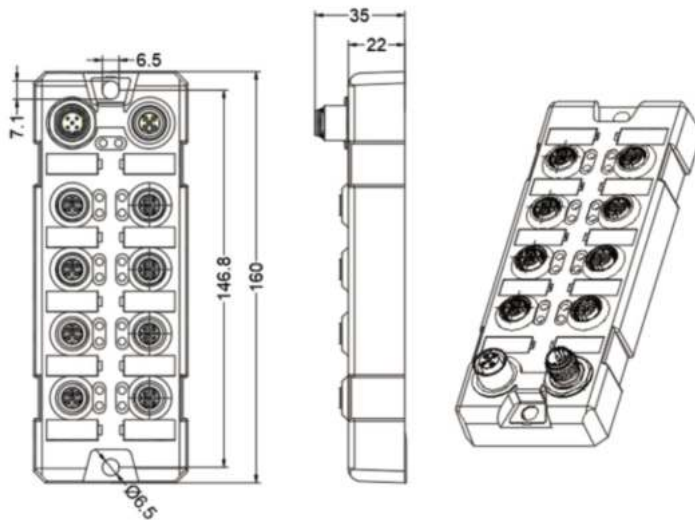

IO-Link interface

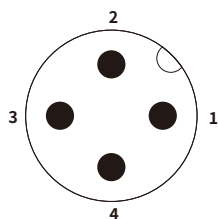

IO-Link Class - A Plug (Metal)
 1-Power supply 24V+
 2-NC
 3-Power supply GND
 4-IO-Link C/Q

Power supply interface / DH Bus interface

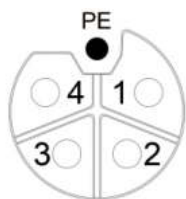

Power supply L-code plug (Metal) - PWR1
 1-System and signal power supply Us+
 2-Actuator Power supply Ua-
 3-System and signal power supply Us-
 4-Actuator Power supply Ua+
 5-PE-Protective grounding PE

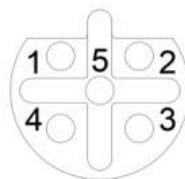

DH Bus B-code socket (Metal) - BUS1
 1-Power supply 24V+
 2-Data signal A
 3-Data signal B
 4-Power supply GND
 5-ADR 1

M12 Input/Output

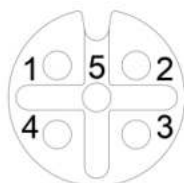

Digital signal interface M12 A-code socket (Green)
 1-Power supply 24V+
 2-Digital Input/Output B
 3-Power supply GND
 4-Digital Input/Output A
 5-Protective grounding PE

Analog/Temperature signal interface M12 A-code socket (Green)
 1- a-
 2- A-
 3- NC
 4- A+
 5- NC

Fieldbus interface module



RoHS

Features

- Advanced diagnostic function
- Fieldbus and Power adopt isolation technology and are reliable
- Supports 2 chain path; Max. 32 modules(16×2)
- Standalone configuration file
- Support DH BUS extension

PROFINET-RT PROTOCOL
Ordering Data

Order No.	DFH67-PN-DI12P-DHB2-V1	DFH67-PN-DI12N-DHB2-V1
Description	PROFINET-RT protocol 6*A-Code 12DI , PNP type 2*B-Code DH BUS interface	PROFINET-RT protocol 6*A-Code 12DI , NPN type 2*B-Code DH BUS interface

Fieldbus

Protocol	PROFINET-RT
Operation mode	Automatic negotiation ; Auto MDI/MDIX
Transmission speed	10/100 Mbps
IP allocation	Programming software configuration , or allocation by master

Power Supply

Working voltage	24 VDC (18...30 VDC)
Current consumption	Max. 200 mA
System and Input	Us , Max. 8A
Actuators	Ua , Max. 8A
DH Bus interface power supply	Current of each DH Bus interface : Max. 4A
Electrical isolation	Module/Input power supply Ui and Output power supply Uo : 24V isolated , 0V connected

Interface Type

Power supply	2 * M12 L-code 5pinPlug(input) + Socket(output)
Fieldbus	2 * M12 D-code 4pin , Socket
Signal	6 * M12 A-code 5pin , Socket
DH Bus interface	2 * M12 B-code 5pin , Socket
Number of DH Bus modules	Max. 32 (16 × 2)
Extension distance of DH Bus	Single chain path: Max. 120m; Between adjacent modules: Max. 15m

Fieldbus interface module

RoHS
Ordering Data

Order No.	DFH67-PN-DI12P-DHB2-V1	DFH67-PN-DI12N-DHB2-V1
-----------	------------------------	------------------------

Electrical parameters

Number and type of I/O	12DI PNP	12DI NPN
Input power supply current	Per channel : Max. 200mA	
Input filter time	Max. 10ms	

Diagnostic

Communication Status	LED indication, Communication message
Power supply	Yes, Low voltage alarm
Short circuit/Overload	Yes, LED indication
Extension	LED indication

General data

Degree of protection	IP67
Temperature range	Operation temperature : -20~60 °C ; Storage temperature : -40~85 °C
Installation	2-hole fixing

Fieldbus interface module



RoHS

Features

- Advanced diagnostic function
- Fieldbus and Power adopt isolation technology and are reliable
- Supports 2 chain path; Max. 32 modules(16×2)
- Standalone configuration file
- Support DH BUS extension

EtherCAT PROTOCOL
Ordering Data

Order No.	DFH67-EC-DI12P-DHB2-V1	DFH67-EC-DI12N-DHB2-V1
Description	EtherCAT protocol 6*A-Code 12DI , PNP type 2*B-Code DH BUS interface	EtherCAT protocol 6*A-Code 12DI , NPN type 2*B-Code DH BUS interface

Fieldbus

Protocol	EtherCAT
Operation mode	Automatic negotiation ; Auto MDI/MDIX
Transmission speed	10/100 Mbps
IP allocation	System automatic allocation or DIP switch setting

Power Supply

Working voltage	24 VDC (18...30 VDC)
Current consumption	Max. 200 mA
System and Input	Us , Max. 8A
Actuators	Ua , Max. 8A
DH Bus interface power supply	Current of each DH Bus interface : Max. 4A
Electrical isolation	Module/Input power supply Ui and Output power supply Uo : 24V isolated , 0V connected

Interface Type

Power supply	2 * M12 L-code 5pinPlug(input) + Socket(output)
Fieldbus	2 * M12 D-code 4pin , Socket
Signal	6 * M12 A-code 5pin , Socket
DH Bus interface	2 * M12 B-code 5pin , Socket
Number of DH Bus modules	Max. 32 (16 × 2)
Extension distance of DH Bus	Single chain path: Max. 120m; Between adjacent modules: Max. 15m

Fieldbus interface module

RoHS

Ordering Data		
Order No.	DFH67-EC-DI12P-DHB2-V1	DFH67-EC-DI12N-DHB2-V1
Electrical parameters		
Number and type of I/O	12DI PNP	12DI NPN
Input power supply current	Per channel : Max. 200mA	
Input filter time	Max. 1.6ms	
Diagnostic		
Communication Status	LED indication, Communication message	
Power supply	Yes, Low voltage alarm	
Short circuit/Overload	Yes, LED indication	
Extension	LED indication	
General data		
Degree of protection	IP67	
Temperature range	Operation temperature : -20~60 °C ; Storage temperature : -40~85 °C	
Installation	2-hole fixing	

Fieldbus interface module



RoHS

CC-Link IE Field Basic PROTOCOL
Features

- Advanced diagnostic function
- Fieldbus and Power adopt isolation technology and are reliable
- Supports 2 chain path; Max. 32 modules(16×2)
- Support DH BUS extension
- Input or Output configurable

Ordering Data

Order No.	DFH67-CLI-DIO12P-DHB2-V1	DFH67-CLI-DIO12N-DHB2-V1
Description	CC-Link IE Field Basic protocol 6*A-Code 12DI/DO(configurable) , PNP type 2*B-Code DH BUS interface	CC-Link IE Field Basic protocol 6*A-Code 12DI/DO(configurable) , NPN type 2*B-Code DH BUS interface

Fieldbus

Protocol	CC-Link IE Field Basic
Operation mode	Automatic negotiation ; Auto MDI/MDIX
Transmission speed	10/100 Mbps
IP allocation	Web server configuration or DIP switch setting

Power Supply

Working voltage	24 VDC (18...30 VDC)
Current consumption	Max. 200 mA
System and Input	Us , Max. 8A
Actuators	Ua , Max. 8A
DH Bus interface power supply	Current of each DH Bus interface : Max. 4A
Electrical isolation	Module/Input power supply Ui and Output power supply Uo : 24V isolated , 0V connected

Interface Type

Power supply	2 * M12 L-code 5pinPlug(input) + Socket(output)
Fieldbus	2 * M12 D-code 4pin , Socket
Signal	6 * M12 A-code 5pin , Socket
DH Bus interface	2 * M12 B-code 5pin , Socket
Number of DH Bus modules	Max. 32 (16 × 2)
Extension distance of DH Bus	Single chain path: Max. 120m; Between adjacent modules: Max. 15m

Fieldbus interface module

RoHS
Ordering Data

Order No.	DFH67-CLI-DIO12P-DHB2-V1	DFH67-CLI-DIO12N-DHB2-V1
-----------	--------------------------	--------------------------

Electrical parameters

Number and type of I/O	12DI/DO(configurable) , PNP type	12DI/DO(configurable) , NPN type
------------------------	----------------------------------	----------------------------------

Input power supply current	Per channel : Max. 200mA
----------------------------	--------------------------

Input filter time	Max. 10ms
-------------------	-----------

Diagnostic

Communication Status	LED indication, Communication message
----------------------	---------------------------------------

Power supply	Yes, Low voltage alarm
--------------	------------------------

Short circuit/Overload	Yes, LED indication
------------------------	---------------------

Extension	LED indication
-----------	----------------

General data

Degree of protection	IP67
----------------------	------

Temperature range	Operation temperature : -20~60 °C ; Storage temperature : -40~85 °C
-------------------	---

Installation	2-hole fixing
--------------	---------------



Features

- Advanced diagnostic function
- Fieldbus and Power adopt isolation technology and are reliable
- Supports 2 chain path; Max. 32 modules(16×2)
- Standalone configuration file
- Support DH BUS extension
- Input or Output configurable

EtherNet/IP PROTOCOL

Ordering Data

Order No.	DFH67-EIP-DIO12P-DHB2-V1	DFH67-EIP-DIO12N-DHB2-V1
Description	EtherNet/IP protocol 6*A-Code 12DI/DO(configurable) , PNP type 2*B-Code DH BUS interface	EtherNet/IP protocol 6*A-Code 12DI/DO(configurable) , NPN type 2*B-Code DH BUS interface

Fieldbus

Protocol	EtherNet/IP
Operation mode	Automatic negotiation ; Auto MDI/MDIX
Transmission speed	10/100 Mbps
IP allocation	Web server configuration or DIP switch setting

Power Supply

Working voltage	24 VDC (18...30 VDC)
Current consumption	Max. 200 mA
System and Input	Us , Max. 8A
Actuators	Ua , Max. 8A
DH Bus interface power supply	Current of single chain path : Max. 4A
Electrical isolation	Module/Input power supply Ui and Output power supply Uo : 24V isolated , 0V connected

Interface Type

Power supply	2 * M12 L-code 5pinPlug(input) + Socket(output)
Fieldbus	2 * M12 D-code 4pin , Socket
Signal	6 * M12 A-code 5pin , Socket
DH Bus interface	2 * M12 B-code 5pin , Socket
Number of DH Bus modules	Max. 32 (16 × 2)
Extension distance of DH Bus	Single chain path: Max. 120m; Between adjacent modules: Max. 15m

Fieldbus interface module

RoHS
Ordering Data

Order No.	DFH67-EIP-DIO12P-DHB2-V1	DFH67-EIP-DIO12N-DHB2-V1
-----------	--------------------------	--------------------------

Electrical parameters

Number and type of I/O	12DI/DO(configurable) , PNP type	12DI/DO(configurable) , NPN type
------------------------	----------------------------------	----------------------------------

Input power supply current	Per channel : Max. 200mA
----------------------------	--------------------------

Input filter time	Max. 20ms
-------------------	-----------

Diagnostic

Communication Status	LED indication, Communication message
----------------------	---------------------------------------

Power supply	Yes, Low voltage alarm
--------------	------------------------

Short circuit/Overload	Yes, LED indication
------------------------	---------------------

Extension	LED indication
-----------	----------------

General data

Degree of protection	IP67
----------------------	------

Temperature range	Operation temperature : -20~60 °C ; Storage temperature : -40~85 °C
-------------------	---

Installation	2-hole fixing
--------------	---------------



Features

- Advanced diagnostic function
- Fieldbus and Power adopt isolation technology and are reliable
- Supports 2 chain path; Max. 32 modules(16×2)
- Standalone configuration file
- Support DH BUS extension
- Input or Output configurable

Modbus-TCP PROTOCOL

Ordering Data		
Order No.	DFH67-MT-DIO12P-DHB2-V1	DFH67-MT-DIO12N-DHB2-V1
Description	Modbus-TCP protocol 6*A-Code 12DI/DO(configurable) , PNP type 2*B-Code DH BUS interface	Modbus-TCP protocol 6*A-Code 12DI/DO(configurable) , NPN type 2*B-Code DH BUS interface
Fieldbus		
Protocol	Modbus-TCP	
Operation mode	Automatic negotiation ; Auto MDI/MDIX	
Transmission speed	10/100 Mbps	
IP allocation	Web server configuration or DIP switch setting	
Power Supply		
Working voltage	24 VDC (18...30 VDC)	
Current consumption	Max. 200 mA	
System and Input	Us , Max. 8A	
Actuators	Ua , Max. 8A	
DH Bus interface power supply	Current of single chain path : Max. 4A	
Electrical isolation	Module/Input power supply Ui and Output power supply Uo : 24V isolated , 0V connected	
Interface Type		
Power supply	2 * M12 L-code 5pinPlug(input) + Socket(output)	
Fieldbus	2 * M12 D-code 4pin , Socket	
Signal	6 * M12 A-code 5pin , Socket	
DH Bus interface	2 * M12 B-code 5pin , Socket	
Number of DH Bus modules	Max. 32 (16 × 2)	
Extension distance of DH Bus	Single chain path: Max. 120m; Between adjacent modules: Max. 15m	

Fieldbus interface module

RoHS
Ordering Data

Order No.	DFH67-MT-DIO12P-DHB2-V1	DFH67-MT-DIO12N-DHB2-V1
-----------	-------------------------	-------------------------

Electrical parameters

Number and type of I/O	12DI/DO(configurable) , PNP type	12DI/DO(configurable) , NPN type
Input power supply current	Per channel : Max. 200mA	
Input filter time	Max. 20ms	

Diagnostic

Communication Status	LED indication, Communication message
Power supply	Yes, Low voltage alarm
Short circuit/Overload	Yes, LED indication
Extension	LED indication

General data

Degree of protection	IP67
Temperature range	Operation temperature : -20~60 °C ; Storage temperature : -40~85 °C
Installation	2-hole fixing

Fieldbus interface module CE RoHS

Dimension

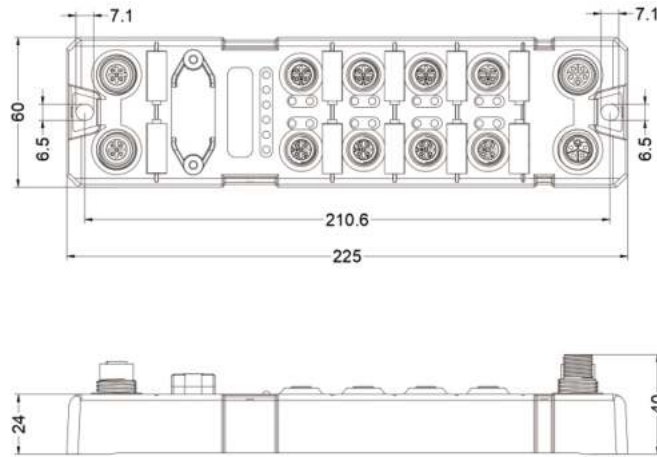

Power supply interface

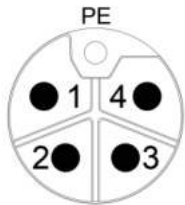

Power supply L-code plug (Metal) - PWR1
 1-System and signal power supply Us+
 2-Actuator Power supply Ua-
 3-System and signal power supply Us-
 4-Actuator Power supply Ua+
 5-PE-Protective grounding PE

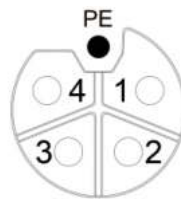

Power supply L-code socket (Metal) - PWR2

Fieldbus & DH BUS interface

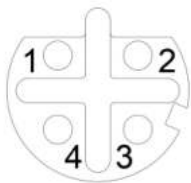

Fieldbus interface D-code socket (Metal) - ETH1/ETH2
 1-Transmitter Tx+
 2-Receiver Rx+
 3-Transmitter Tx-
 4-Receiver Rx-

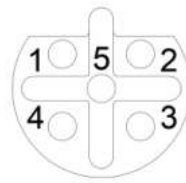

DH Bus B-code socket (Black) - D01/D02
 1-Power supply 24V+
 2-Data signal A
 3-Data signal B
 4-Power supply GND
 5-ADR 1

I/O signal interface

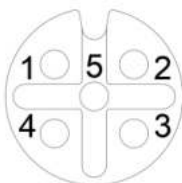

I/O signal interface M12 A-code socket (Green)
 1-Power supply 24V+
 2-Digital Input/Output B
 3-Power supply GND
 4-Digital Input/Output A
 5-Protective grounding PE



Features

- Input/Output photoelectric isolation
- Hardware filtering time 500us
- Output photoelectric isolation
- Overvoltage and short circuit protection function
- DH BUS and Channel adopt isolation technology and are reliable

16 digital inputs module

Ordering Data		
Order No.	DFH67-DHB-DI16P-M12-V1	DFH67-DHB-DI16N-M12-V1
Description	16DI , PNP , 8*M12	16DI , NPN , 8*M12
Interface type		
DH Bus	2 * M12 B-code 5pin Plug(input) + Socket(output)	
Power	DH Bus interface includes power supply	
Signal	8 * M12 A-code 5pin , Socket	
Electrical parameters		
Supply Voltage	24 VDC (18...30V)	
Current consumption	Max. 50mA	
Number of inputs	16	
Input power supply current	Per channel : Max. 200mA	
Input signal type	PNP type Sensors, Limit switch, Contact, etc	NPN type Sensors, Limit switch, Contact, etc
Input filter time	Max. 2ms	
Number of outputs	/	
Output current	/	
Output signal type	/	
Output switch frequency	/	
Diagnostic		
Communication Status	LED indication, Communication message	
Power supply	Yes, Low voltage alarm	
Short circuit/Overload	Yes, LED indication	
General data		
Degree of protection	IP67	
Temperature range	Operation temperature : -20~60 °C ; Storage temperature : -40~85 °C	
Installation	2-hole fixing	

DH BUS extension module



RoHS

Features

- Input/Output photoelectric isolation
- Hardware filtering time 500us
- Output photoelectric isolation
- Overvoltage and short circuit protection function
- DH BUS and Channel adopt isolation technology and are reliable

16 digital outputs module

Ordering Data		
Order No.	DFH67-DHB-DO16P-M12-V1	DFH67-DHB-DO16N-M12-V1
Description	16DO , PNP , 8*M12	16DO , NPN , 8*M12
Interface type		
DH Bus	2 * M12 B-code 5pin Plug(input) + Socket(output)	
Power	DH Bus interface includes power supply	
Signal	8 * M12 A-code 5pin , Socket	
Electrical parameters		
Supply Voltage	24 VDC (18...30V)	
Current consumption	Max. 50mA	
Number of inputs	/	
Input power supply current	/	
Input signal type	/	
Input filter time	/	
Number of outputs	16	
Output current	Per channel : Max. 0.5A	
Output signal type	PNP type, actuator, Indicator, etc	NPN type, actuator, Indicator, etc
Output switch frequency	Resistive load : 100Hz, Inductive load : 5Hz	
Diagnostic		
Communication Status	LED indication, Communication message	
Power supply	Yes, Low voltage alarm	
Short circuit/Overload	Yes, LED indication	
General data		
Degree of protection	IP67	
Temperature range	Operation temperature : -20~60 °C ; Storage temperature : -40~85 °C	
Installation	2-hole fixing	

DH BUS extension module

Features

- Input/Output photoelectric isolation
- Hardware filtering time 500us
- Output photoelectric isolation
- Overvoltage and short circuit protection function
- DH BUS and Channel adopt isolation technology and are reliable

8 digital inputs + 8 digital outputs module

Ordering Data		
Order No.	DFH67-DHB-DI8P-DO8P-M12-V1	DFH67-DHB-DI8N-DO8N-M12-V1
Description	8DI+8DO,PNP,8*M12	8DI+8DO,NPN,8*M12
Interface type		
DH Bus	2 * M12 B-code 5pin Plug(input) + Socket(output)	
Power	DH Bus interface includes power supply	
Signal	8 * M12 A-code 5pin , Socket	
Electrical parameters		
Supply Voltage	24 VDC (18...30V)	
Current consumption	Max. 50mA	
Number of inputs	8	
Input power supply current	Per channel : Max. 200mA	
Input signal type	PNP type Sensors, Limit switch, Contact, etc	NPN type Sensors, Limit switch, Contact, etc
Input filter time	Max. 2ms	
Number of outputs	8	
Output current	Per channel : Max. 0.5A	
Output signal type	PNP type, actuator, Indicator, etc	NPN type, actuator, Indicator, etc
Output switch frequency	Resistive load : 100Hz, Inductive load : 5Hz	
Diagnostic		
Communication Status	LED indication, Communication message	
Power supply	Yes, Low voltage alarm	
Short circuit/Overload	Yes, LED indication	
General data		
Degree of protection	IP67	
Temperature range	Operation temperature : -20~60 °C ; Storage temperature : -40~85 °C	
Installation	2-hole fixing	

DH BUS extension module



RoHS

Features

- Input photoelectric isolation
- Hardware filtering time 500us
- Overvoltage and short circuit protection function
- DH BUS and Channel adopt isolation technology and are reliable

8 digital inputs module

Ordering Data		
Order No.	DFH67-DHB-DI8P-M08-V1	DFH67-DHB-DI8N-M08-V1
Description	8DI , PNP , 8*M8	8DI , NPN , 8*M8
Interface type		
DH Bus	2 * M12 B-code 5pin Plug(input) + Socket(output)	
Power	DH Bus interface includes power supply	
Signal	8 * M8 A-code 3pin , Socket	
Electrical parameters		
Supply Voltage	24 VDC (18...30V)	
Current consumption	Max. 50mA	
Number of inputs	8	
Input power supply current	Per channel : Max. 200mA	
Input signal type	PNP type Sensors, Limit switch, Contact, etc	NPN type Sensors, Limit switch, Contact, etc
Input filter time	Max. 2ms	
Number of outputs	/	
Output current	/	
Output signal type	/	
Output switch frequency	/	
Diagnostic		
Communication Status	LED indication, Communication message	
Power supply	Yes, Low voltage alarm	
Short circuit/Overload	Yes, LED indication	
General data		
Degree of protection	IP67	
Temperature range	Operation temperature : -20~60 °C ; Storage temperature : -40~85 °C	
Installation	2-hole fixing	

DH BUS extension module



RoHS

Features

- Input photoelectric isolation
- Hardware filtering time 500us
- Overvoltage and short circuit protection function
- DH BUS and Channel adopt isolation technology and are reliable

8 digital outputs module
Ordering Data

Order No.	DFH67-DHB-DO8P-M08-V1	DFH67-DHB-DO8N-M08-V1
Description	8DO , PNP , 8*M8	8DO , NPN , 8*M8

Interface type

DH Bus	2 * M12 B-code 5pin Plug(input) + Socket(output)
Power	DH Bus interface includes power supply
Signal	8 * M8 A-code 3pin , Socket

Electrical parameters

Supply Voltage	24 VDC (18...30V)
Current consumption	Max. 50mA
Number of inputs	/
Input power supply current	/
Input signal type	/
Input filter time	/
Number of outputs	8
Output current	Per channel : Max. 0.5A , Total : Max. 4A
Output signal type	NPN type, actuator, Indicator, etc
Output switch frequency	Resistive load : 100Hz, Inductive load : 5Hz

Diagnostic

Communication Status	LED indication, Communication message
Power supply	Yes, Low voltage alarm
Short circuit/Overload	Yes, LED indication

General data

Degree of protection	IP67
Temperature range	Operation temperature : -20~60 °C ; Storage temperature : -40~85 °C
Installation	2-hole fixing

DH BUS extension module

RoHS

Features

- Input photoelectric isolation
- Hardware filtering time 500us
- Overvoltage and short circuit protection function
- DH BUS and Channel adopt isolation technology and are reliable

4 digital inputs + 4 digital outputs module

Ordering Data		
Order No.	DFH67-DHB-DI4P-DO4P-M08-V1	DFH67-DHB-DI4N-DO4N-M08-V1
Description	4DI+4DO,PNP,8*M8	4DI+4DO,NPN,8*M8
Interface type		
DH Bus	2 * M12 B-code 5pin Plug(input) + Socket(output)	
Power	DH Bus interface includes power supply	
Signal	8 * M8 A-code 3pin , Socket	
Electrical parameters		
Supply Voltage	24 VDC (18...30V)	
Current consumption	Max. 50mA	
Number of inputs	4	
Input power supply current	Per channel : Max. 200mA	
Input signal type	PNP type Sensors, Limit switch, Contact, etc	NPN type Sensors, Limit switch, Contact, etc
Input filter time	Max. 2ms	
Number of outputs	4	
Output current	Per channel : Max. 0.5A , Total : Max. 4A	
Output signal type	PNP type, actuator, Indicator, etc	NPN type, actuator, Indicator, etc
Output switch frequency	Resistive load : 100Hz, Inductive load : 5Hz	
Diagnostic		
Communication Status	LED indication, Communication message	
Power supply	Yes, Low voltage alarm	
Short circuit/Overload	Yes, LED indication	
General data		
Degree of protection	IP67	
Temperature range	Operation temperature : -20~60 °C ; Storage temperature : -40~85 °C	
Installation	2-hole fixing	

DH BUS extension module

Features

- Input/Output photoelectric isolation
- Hardware filtering time 500us
- Input or Output configurable
- Overvoltage and short circuit protection function
- DH BUS and Channel adopt isolation technology and are reliable

16 configurable digital I/O module

Ordering Data		
Order No.	DFH67-DHB-DIO16P-M12-V1	DFH67-DHB-DIO16N-M12-V1
Description	16 DI/DO , PNP , 8*M12	16 DI/DO , NPN , 8*M12
Interface type		
DH Bus	2 * M12 B-code 5pin Plug(input) + Socket(output)	
Power	DH Bus interface includes power supply	
Signal	8 * M12 A-code 5pin , Socket	
Electrical parameters		
Supply Voltage	24 VDC (18...30V)	
Current consumption	Max. 50mA	
Number of inputs	Max. 16	
Input power supply current	Per channel : Max. 200mA	
Input signal type	PNP type Sensors, Limit switch, Contact, etc	NPN type Sensors, Limit switch, Contact, etc
Input filter time	Max. 2ms	
Number of outputs	Max. 16	
Output current	Per channel : Max. 0.5A , Total : Max. 4A	
Output signal type	PNP type, actuator, Indicator, etc	NPN type, actuator, Indicator, etc
Output switch frequency	Resistive load : 100Hz, Inductive load : 5Hz	
Diagnostic		
Communication Status	LED indication, Communication message	
Power supply	Yes, Low voltage alarm	
Short circuit/Overload	Yes, LED indication	
General data		
Degree of protection	IP67	
Temperature range	Operation temperature : -20~60 °C ; Storage temperature : -40~85 °C	
Installation	2-hole fixing	

Features

- Rich variety and wide application range
- The measure range configured through XML file, more flexible
- DH BUS and Channel adopt isolation technology and are reliable

Analog input module
Ordering Data

Order No.	DFH67-DHB-AI4I-M12-V1	DFH67-DHB-AI8I-M12-V1	DFH67-DHB-AI4U-M12-V1	DFH67-DHB-AI8U-M12-V1
Description	4AI (Current type) , 16 bit , 4*M12	8AI (Current type) , 16 bit , 8*M12	4AI (Voltage type) , 16 bit , 4*M12	8AI (Voltage type) , 16 bit , 8*M12

Interface type

DH Bus	2 * M12 B-code 5pin Plug(input) + Socket(output)			
Power	DH Bus interface includes power supply			
Signal	4 * M12 A-code 5pin , Socket	8 * M12 A-code 5pin , Socket	4 * M12 A-code 5pin , Socket	8 * M12 A-code 5pin , Socket

Electrical parameters

Supply Voltage	24 VDC (18...30V)			
Current consumption	Max. 50mA			
Number of inputs	4	8	4	8
Input power supply current	Per channel : Max. 200mA			
Input signal type	0...20mA , 4...20mA , ±20mA		0...10V , ±10V	
Input impedance	250Ω		1MΩ	
Resolution	16 Bit			
Conversion time	Max. 300us			
Precision	± 0.3%			

Diagnostic

Communication Status	LED indication, Communication message
Power supply	Yes, Low voltage alarm
Short circuit/Overload	Yes, LED indication

General data

Degree of protection	IP67
Temperature range	Operation temperature : -20~60 °C ; Storage temperature : -40~85 °C
Installation	2-hole fixing

DH BUS extension module

Features

- Resolution : 16 bit
- The measure range configured through XML file, more flexible
- DH BUS and Channel adopt isolation technology and are reliable

8 channel analog output module
Ordering Data

Order No.	DFH67-DHB-AO4I-AO4U-M12-V1	DFH67-DHB- AO8I-M12-V1	DFH67-DHB-AO8U-M12-V1
Description	4AO(Current type)+4AO(Voltage type),16 bit,8*M12	8AO(Current type),16 bit,8*M12	8AO(Voltage type),16 bit,8*M12

Interface type

DH Bus	2 * M12 B-code 5pin Plug(input) + Socket(output)
Power	DH Bus interface includes power supply
Signal	8 * M12 A-code 5pin , Socket

Electrical parameters

Supply Voltage	24 VDC (18...30V)		
Current consumption	Max. 50mA		
Number of outputs	8		
Output signal type	First 4 channels (0...20mA,4...20mA) Last 4 channels (0...10V,±10V)	0...20mA , 4...20mA	0...10V , ±10V
Output impedance	Current type :<500Ω; Voltage type :>1kΩ	< 450Ω	> 1kΩ
Resolution	16 Bit		
Conversion time	Max. 300us		
Precision	± 0.3%		

Diagnostic

Communication Status	LED indication, Communication message
Power supply	Yes, Low voltage alarm
Short circuit/Overload	Yes, LED indication

General data

Degree of protection	IP67
Temperature range	Operation temperature : -20~60 °C ; Storage temperature : -40~85 °C
Installation	2-hole fixing

DH BUS extension module

RoHS

Features

- Resolution : 16 bit
- The measure range configured through XML file, more flexible
- DH BUS and Channel adopt isolation technology and are reliable

4 channel analog output module
Ordering Data

Order No.	DFH67-DHB-AO4I-M12-V1	DFH67-DHB-AO4U-M12-V1
Description	4AO(Current type),16 bit,4*M12	4AO(Voltage type),16 bit,4*M12

Interface type

DH Bus	2 * M12 B-code 5pin Plug(input) + Socket(output)
Power	DH Bus interface includes power supply
Signal	8 * M12 A-code 5pin , Socket

Electrical parameters

Supply Voltage	24 VDC (18...30V)	
Current consumption	Max. 50mA	
Number of outputs	4	
Output signal type	0...20mA , 4...20mA	0...10V , ±10V
Output impedance	< 450Ω	> 1kΩ
Resolution	16 Bit	
Conversion time	Max. 300us	
Precision	± 0.3%	

Diagnostic

Communication Status	LED indication, Communication message
Power supply	Yes, Low voltage alarm
Short circuit/Overload	Yes, LED indication

General data

Degree of protection	IP67
Temperature range	Operation temperature : -20~60 °C ; Storage temperature : -40~85 °C
Installation	2-hole fixing

DH BUS extension module

Features

- Resolution : 16 bit
- The measure range configured through XML file, more flexible
- DH BUS and Channel adopt isolation technology and are reliable

4 analog inputs + 4 analog outputs module

Ordering Data		
Order No.	DFH67-DHB-AI4I-AO4I-M12-V1	DFH67-DHB-AI4U-AO4U-M12-V1
Description	4AI+4AO(Current type),16 bit,8*M12	4AI+4AO(Voltage type),16 bit,8*M12
Interface type		
DH Bus	2 * M12 B-code 5pin Plug(input) + Socket(output)	
Power	DH Bus interface includes power supply	
Signal	8 * M12 A-code 5pin , Socket	
Electrical parameters		
Supply Voltage	24 VDC (18...30V)	
Current consumption	Max. 50mA	
Number of inputs	4	4
Input signal type	0...20mA , 4...20mA , ± 20 mA	0...10V , ± 10 V
Input impedance	250 Ω	1M Ω
Number of outputs	4	4
Output signal type	0...20mA , 4...20mA	0...10V , ± 10 V
Output impedance	< 450 Ω	> 1k Ω
Resolution	16 bit	
Conversion time	Max. 300us	
Precision	$\pm 0.3\%$	
Diagnostic		
Communication Status	LED indication, Communication message	
Power supply	Yes, Low voltage alarm	
Short circuit/Overload	Yes, LED indication	
General data		
Degree of protection	IP67	
Temperature range	Operation temperature : -20~60 °C ; Storage temperature : -40~85 °C	
Installation	2-hole fixing	



Features

- Resolution : 16 bit
- The measure range configured through XML file, more flexible
- Advanced filtering algorithm for more stable sampling
- DH BUS and Channel adopt isolation technology and are reliable

Temperature measuring module

Ordering Data

Order No.	DFH67-DHB-RTD4-M12-V1	DFH67-DHB-RTD8-M12-V1	DFH67-DHB-TC4-M12-V1 Planned model	DFH67-DHB-TC8-M12-V1 Planned model
Description	4RTD , Thermal resistance , 16 bit , 4*M12	8RTD , Thermal resistance , 16 bit , 8*M12	4TC , Thermocouple, 16 bit , 4*M12	8TC , Thermocouple, 16 bit , 8*M12

Interface type

DH Bus	2 * M12 B-code 5pin Plug(input) + Socket(output)			
Power	DH Bus interface includes power supply			
Signal	4 * M12 A-code 5pin , Socket	8 * M12 A-code 5pin , Socket	4 * M12 A-code 5pin , Socket	8 * M12 A-code 5pin , Socket

Electrical parameters

Supply Voltage	24 VDC (18...30V)			
Current consumption	Max. 50mA			
Number of inputs	4	8	4	8
Input power supply current	Per channel : Max. 200mA			
Input signal type	Pt 100 , Pt1000 , Ni100 , Ni1000 , 0-150/300/600/3000 Ω		B, E, J, K, N, R, S, T Type	
Resolution	16 Bit			
Conversion time	Max. 300us			
Precision	± 0.3%			

Diagnostic

Communication Status	LED indication, Communication message
Power supply	Yes, Low voltage alarm
Short circuit/Overload	Yes, LED indication

General data

Degree of protection	IP67
Temperature range	Operation temperature : -20-60 °C ; Storage temperature : -40-85 °C
Installation	2-hole fixing

DH BUS extension module



Dimension

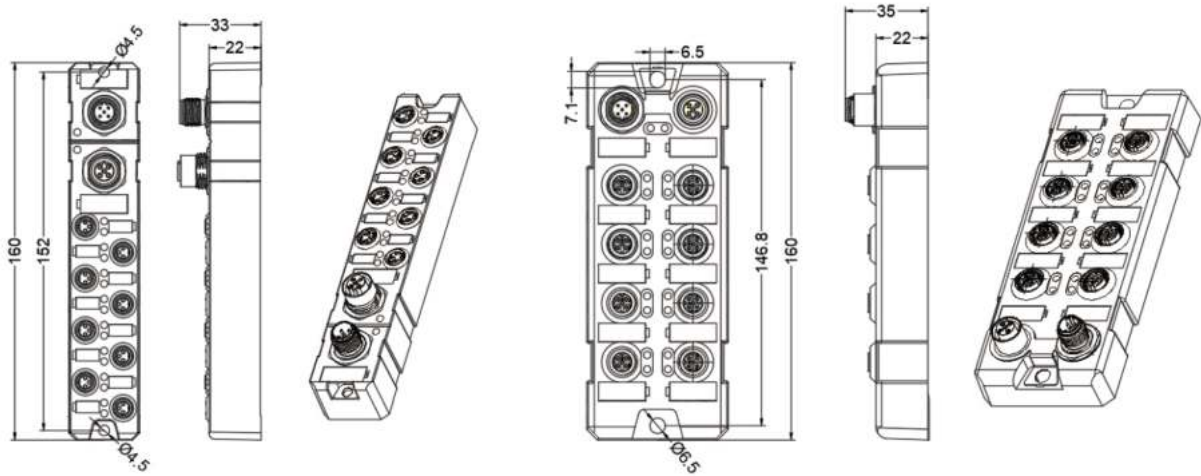

DH Bus interface



DH Bus B-code plug (Metal) - BUS1
 1-Power supply 24V+
 2-Data signal A
 3-Data signal B
 4-Power supply GND
 5-ADR 1

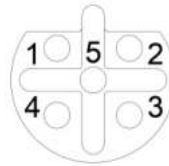

DH Bus B-code socket (Metal) - BUS2
 1-Power supply 24V+
 2-Data signal A
 3-Data signal B
 4-Power supply GND
 5-ADR 1

M12 Input/Output

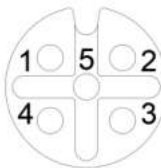

Digital signal interface M12 A-code socket (Green)
 1-Power supply 24V+
 2-Digital Input/Output B
 3-Power supply GND
 4-Digital Input/Output A
 5-Protective grounding PE

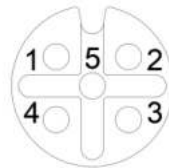

Analog/Temperature signal interface M12 A-code socket (Green)
 1- a-
 2- A-
 3- NC
 4- A+
 5- NC

M8 Input/Output

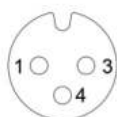

DI/DO signal interface M8 A-code socket (Green)
 1-Power supply 24V+
 3-Power supply GND
 4-Digital Input/Output

Upper control - Fieldbus module Cable

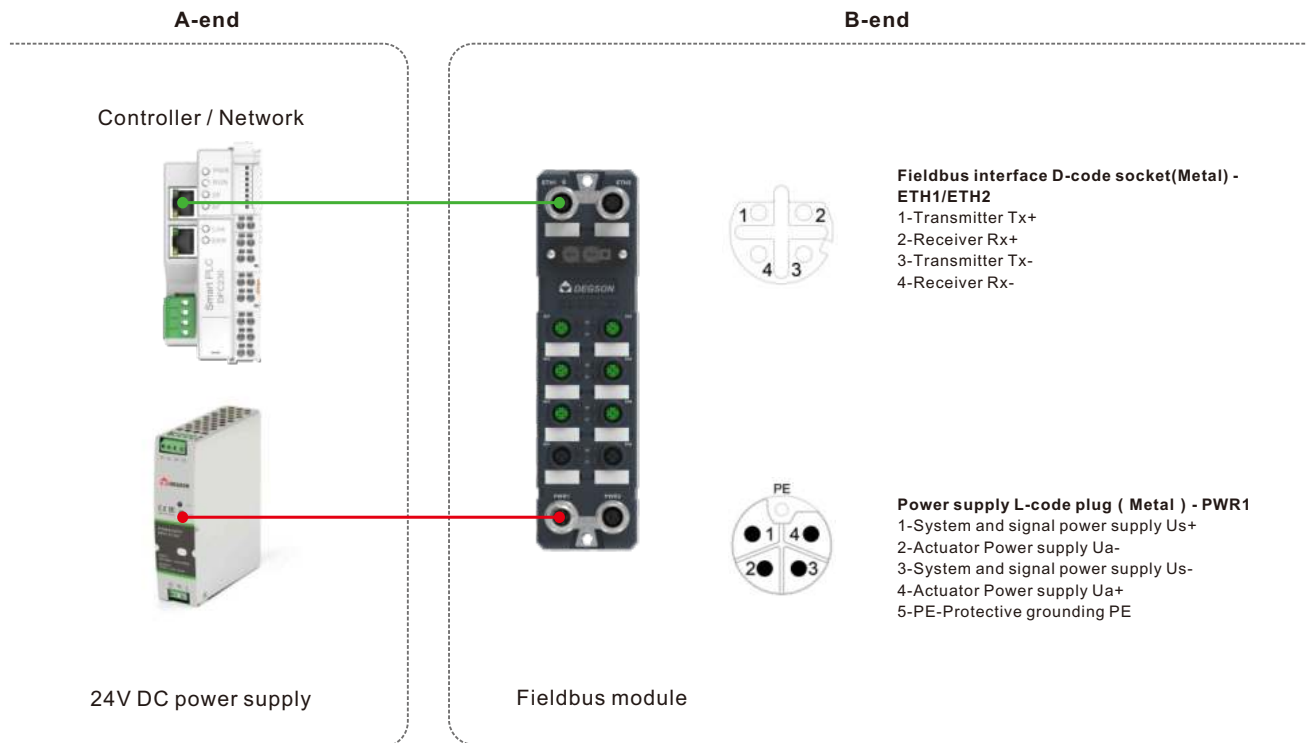

A-end			B-end			Cable		Order NO.
Connect Target	Style	Shape	Connect Target	Style	Shape	Material	Length	
Power connection at the power supply end	Wire	/	Fieldbus module Power input interface M12 L-code 5pin plug	M12 L-code 5pin socket	Straight	PVC	3m 5m 10m 15m 20m	PM-M12L-05P-FF-SL7C03-00Z(H) PM-M12L-05P-FF-SL7C05-00Z(H) PM-M12L-05P-FF-SL7C10-00Z(H) PM-M12L-05P-FF-SL7C15-00Z(H) PM-M12L-05P-FF-SL7C20-00Z(H)
					Angled		3m 5m 10m 15m 20m	PM-M12L-05P-FF-SR7C03-00Z(H) PM-M12L-05P-FF-SR7C05-00Z(H) PM-M12L-05P-FF-SR7C10-00Z(H) PM-M12L-05P-FF-SR7C15-00Z(H) PM-M12L-05P-FF-SR7C20-00Z(H)
Network interface	RJ45	Straight	Fieldbus module Fieldbus interface M12 D-code 4pin socket	M12 D-code 4pin plug	Straight	Shielded	3m 5m 10m 15m 20m	PMSH-M12D-04P-MM-SL8E03-RJ45 PMSH-M12D-04P-MM-SL8E05-RJ45 PMSH-M12D-04P-MM-SL8E10-RJ45 PMSH-M12D-04P-MM-SL8E15-RJ45 PMSH-M12D-04P-MM-SL8E20-RJ45
					Angled		3m 5m 10m 15m 20m	PMSH-M12D-04P-MM-SR8E03-RJ45 PMSH-M12D-04P-MM-SR8E05-RJ45 PMSH-M12D-04P-MM-SR8E10-RJ45 PMSH-M12D-04P-MM-SR8E15-RJ45 PMSH-M12D-04P-MM-SR8E20-RJ45

Note 1: L-code angled cables have a long lead time and should be carefully purchased

Note 2: Other lengths of cables are not in regular stock. If necessary, please contact sales personnel

Fieldbus module - Fieldbus module Cable

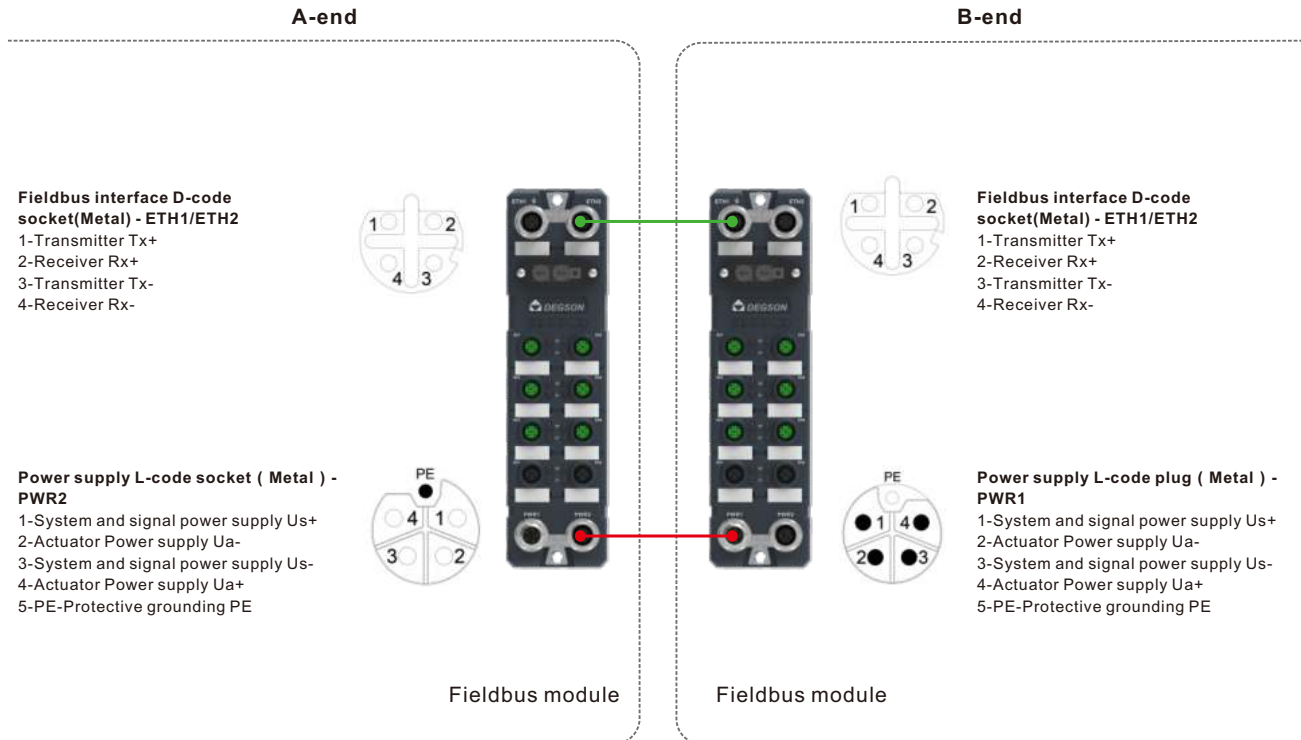

A-end			B-end			Cable		Order NO.		
Connect Target	Style	Shape	Connect Target	Style	Shape	Material	Length			
Fieldbus module Power input interface M12 L-code 5pin socket	M12 L-code 5pin plug	Straight	Fieldbus module Power input interface M12 L-code 5pin plug	M12 L-code 5pin socket	Straight	PVC	1m 2m 3m 5m 10m	PM-M12L-05P-ML-FL-7C01-00Z(H) PM-M12L-05P-ML-FL-7C02-00Z(H) PM-M12L-05P-ML-FL-7C03-00Z(H) PM-M12L-05P-ML-FL-7C05-00Z(H) PM-M12L-05P-ML-FL-7C10-00Z(H)		
		Angled			Angled		1m 2m 3m 5m 10m		PM-M12L-05P-MR-FR-7C01-00Z(H) PM-M12L-05P-MR-FR-7C02-00Z(H) PM-M12L-05P-MR-FR-7C03-00Z(H) PM-M12L-05P-MR-FR-7C05-00Z(H) PM-M12L-05P-MR-FR-7C10-00Z(H)	
Fieldbus module Fieldbus interface M12 D-code 4pin socket	M12 D-code 4pin plug	Straight	Fieldbus module Fieldbus interface M12 D-code 4pin socket	M12 D-code 4pin plug	Straight		Shielded		1m 2m 3m 5m 10m	PMSH-M12D-04P-ML-ML-8E01-00Z(H) PMSH-M12D-04P-ML-ML-8E02-00Z(H) PMSH-M12D-04P-ML-ML-8E03-00Z(H) PMSH-M12D-04P-ML-ML-8E05-00Z(H) PMSH-M12D-04P-ML-ML-8E10-00Z(H)
		Angled			Angled				1m 2m 3m 5m 10m	

Note 1: L-code angled cables have a long lead time and should be carefully purchased

Note 2: Other lengths of cables are not in regular stock. If necessary, please contact sales personnel

Fieldbus module - IO-Link device Cable

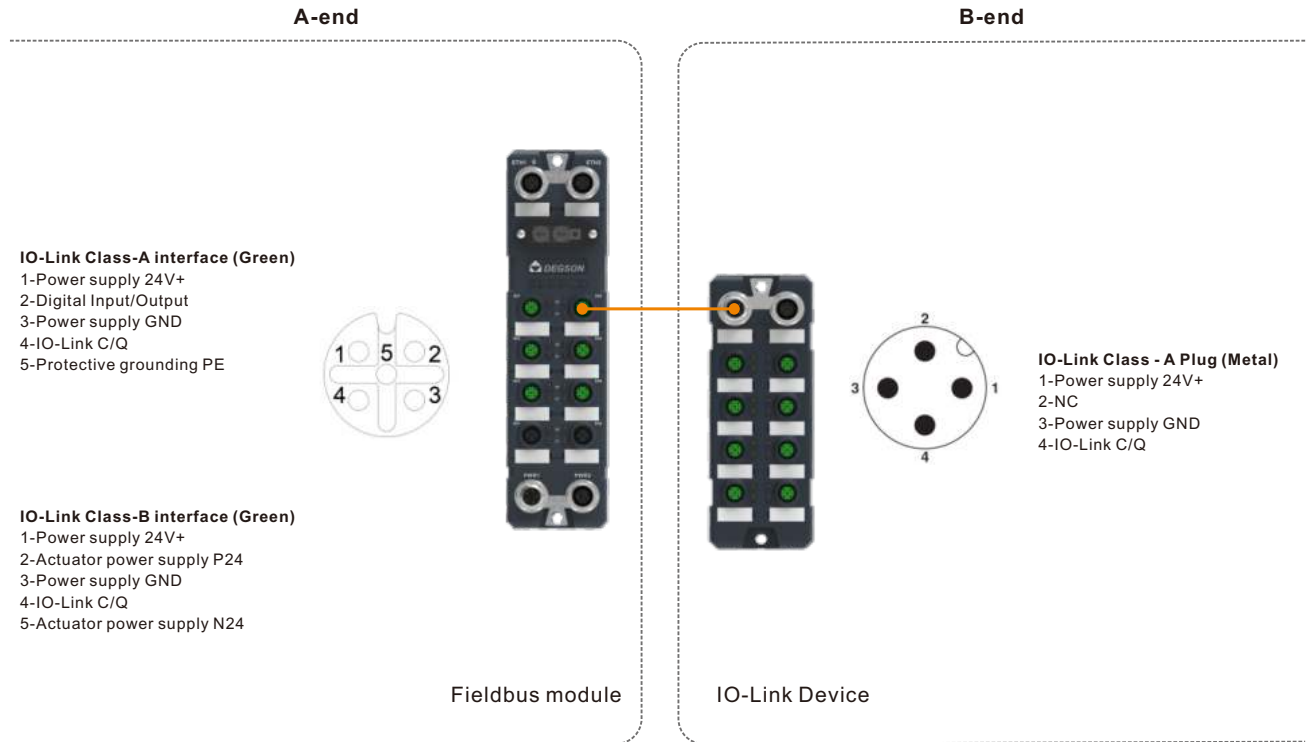

A-end			B-end			Cable		Order NO.
Connect Target	Style	Shape	Connect Target	Style	Shape	Material	Length	
Fieldbus module IO-Link interface M12 A-code 5pin socket	M12 A-code 5pin plug	Straight	IO-Link module IO-Link interface M12 A-code 4pin plug	M12 A-code 5pin socket (Pin5 None)	Straight	PVC	0.3m	PM-M12A-05P-ML-FL-7C-300-00Z(H) PM-M12A-05P-ML-FL-7C-500-00Z(H) PM-M12A-05P-ML-FL-7C01-00Z(H) PM-M12A-05P-ML-FL-7C02-00Z(H) PM-M12A-05P-ML-FL-7C03-00Z(H) PM-M12A-05P-ML-FL-7C05-00Z(H) PM-M12A-05P-ML-FL-7C10-00Z(H)
							0.5m	
		1m						
		2m						
3m								
5m								
10m								
Angled	Angled	0.3m	PM-M12A-05P-MR-FR-7C-300-00Z(H) PM-M12A-05P-MR-FR-7C-500-00Z(H) PM-M12A-05P-MR-FR-7C01-00Z(H) PM-M12A-05P-MR-FR-7C02-00Z(H) PM-M12A-05P-MR-FR-7C03-00Z(H) PM-M12A-05P-MR-FR-7C05-00Z(H) PM-M12A-05P-MR-FR-7C10-00Z(H)					
		0.5m						
1m								
2m								
3m								
5m								
10m								

Note 1: If the IO-Link module requires L-code cables (Power supply), the selection is the same as that of Fieldbus module
 Note 2: If the IO-Link module requires B-code cables (DH Bus), the selection is the same as that of DH Bus module
 Note 3: Other lengths of cables are not in regular stock. If necessary, please contact sales personnel

Sensor / Actuator Cable

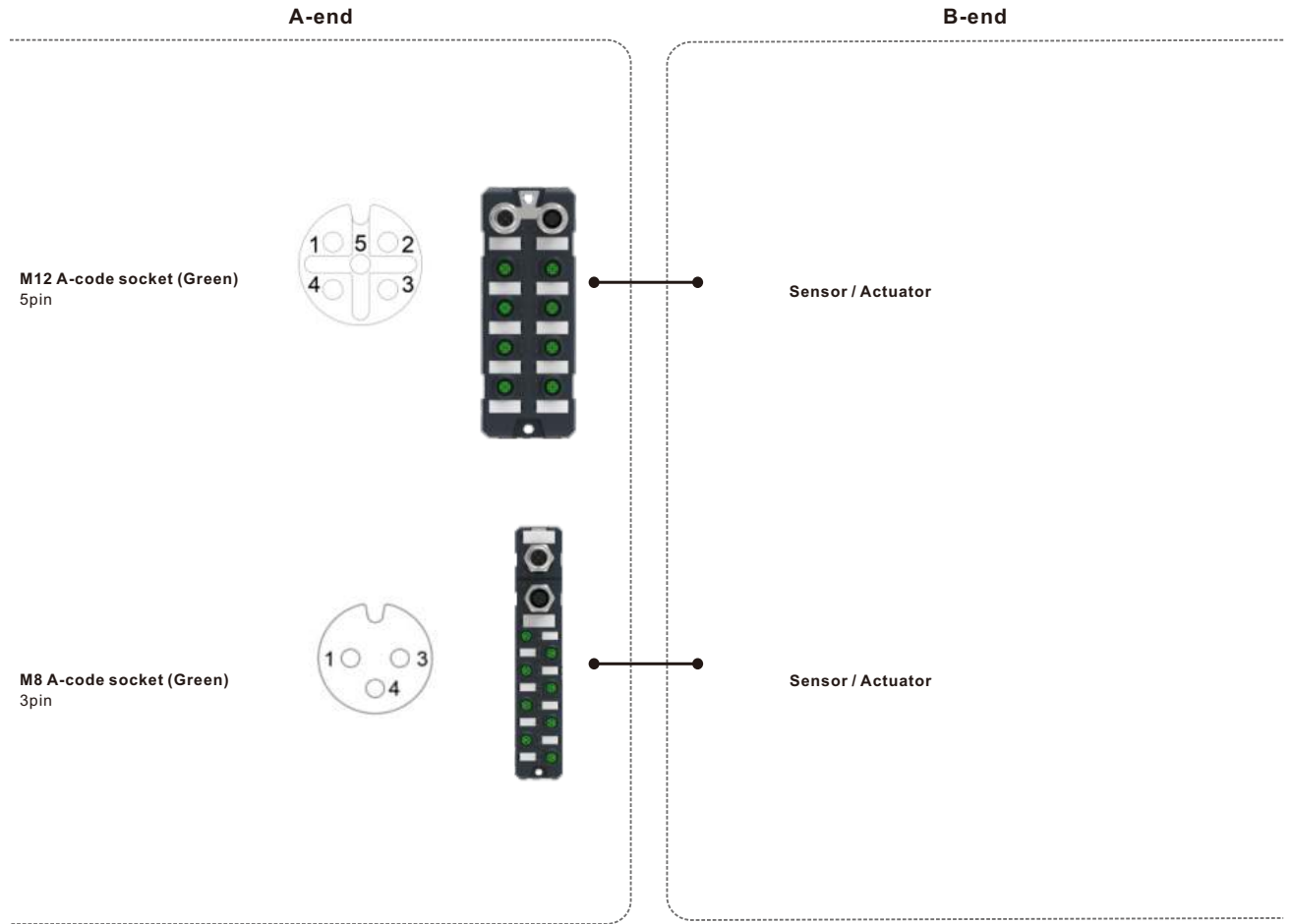

A-end			B-end			Cable		Order NO.
Connect Target	Style	Style	Connect Target	Style	Style	Material	Length	
M12 A-code interface 5pin socket	M12 A-code 5pin plug	Straight	Sensor / Actuator	Wire	Straight	PVC	1m	PM-M12A-05P-MM-SL8C01-00Z(H) PM-M12A-05P-MM-SL8C02-00Z(H) PM-M12A-05P-MM-SL8C03-00Z(H) PM-M12A-05P-MM-SL8C05-00Z(H) PM-M12A-05P-MM-SL8C10-00Z(H)
							2m	
		3m						
		5m						
Angled	Angled	10m						
		1m	PVC	PM-M12A-05P-MM-SR8C01-00Z(H) PM-M12A-05P-MM-SR8C02-00Z(H) PM-M12A-05P-MM-SR8C03-00Z(H) PM-M12A-05P-MM-SR8C05-00Z(H) PM-M12A-05P-MM-SR8C10-00Z(H)				
2m								
3m								
5m								
Angled	Angled	10m						
		1m		PVC	PM-M8A-03P-MM-SL7C01-00Z(H) PM-M8A-03P-MM-SL7C02-00Z(H) PM-M8A-03P-MM-SL7C03-00Z(H) PM-M8A-03P-MM-SL7C05-00Z(H) PM-M8A-03P-MM-SL7C10-00Z(H)			
2m								
3m								
5m								
Angled	Angled	10m						
		1m	PVC		PM-M8A-03P-MM-SR7C01-00Z(H) PM-M8A-03P-MM-SR7C02-00Z(H) PM-M8A-03P-MM-SR7C03-00Z(H) PM-M8A-03P-MM-SR7C05-00Z(H) PM-M8A-03P-MM-SR7C10-00Z(H)			
2m								
3m								
5m								
Angled	Angled	10m						
		10m						

Note : Other lengths of cables are not in regular stock. If necessary, please contact sales personnel



DH Bus accessories

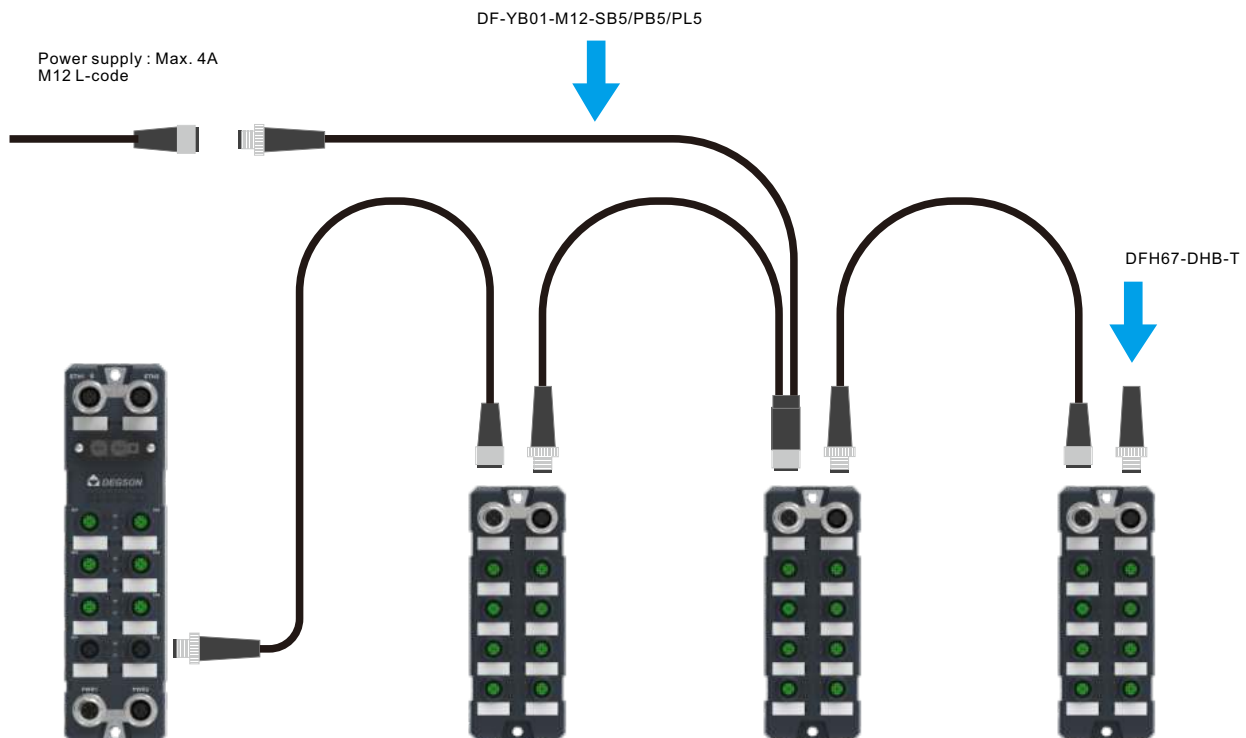
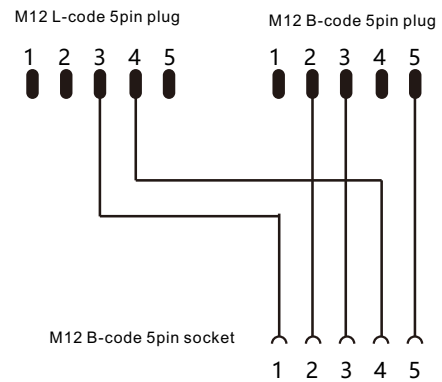

Picture	
Description	DH Bus auxiliary power supply unit
Order NO.	DF-YB01-M12-SB5/PB5/PL5
Style	M12 B-code 5pin socket M12 B-code 5pin plug M12 L-code 5pin plug
Voltage/Current	24V / 4A
Rated voltage	60V
Pulse voltage	2500V
Protection degrees	IP67 / IP68
Notes	When the power supply is insufficient, increase the maximum 4A power supply

Picture	
Description	Termination resistor
Order NO.	DFH67-DHB-T
Style	M12 B-code 5pin plug
Resistance value	Pin4 / Pin5 = 120Ω
Protection degrees	IP67 / IP68

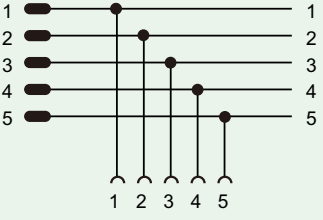
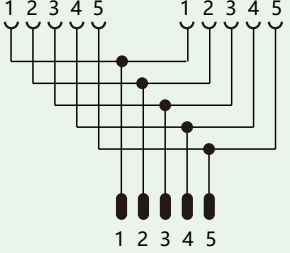
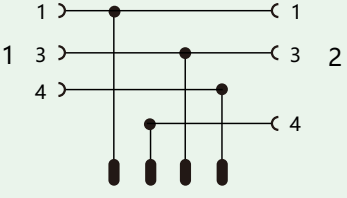

Accessories

Picture			
Description	M12 L-code 5pin T-type distributor	M12 A-code 5pin Y-type distributor	M12 A-code - M8 A-code Y-type distributor
Order NO.	DF-TB-M12-PL5/SL5/SL5	FY-M12A-05F-M12A-05M-Q-0100	FY-M12A-04M-M8A-03F-T-0100
Voltage/Current	24V / 4A	24V / 4A	24V / 3A
Style	Plug / Socket / Socket	Plug / Socket / Socket	M12 4pin Plug / M8 3pin Socket / M8 3pin Socket
Shielding	Unshielded	Unshielded	Unshielded
Diagram			

Description	Order NO.	MOQ	Picture
M12 Plug Cover	DF-PLUGCOVER-M12	10	
M12 Socket Cover	DF-SOCKETCOVER-M12	10	
M8 Socket Cover	DF-SOCKETCOVER-M08	10	

DSW series unmanaged switch



- Wide range working temperature: -40°C ~ 70°C
- Wide range working voltage: DC9.6~60V & AC18~30V
- High strength cast aluminum shell, greatly improving EMC electromagnetic compatibility and heat dissipation performance, vibration and impact resistance
- High data exchange performance, backplane bandwidth: 16Gbps; MAC address table size: 4K; Package cache area: 1.5Mb
- BSP Broadcast storm suppression function improves network stability
- QoS priority function ensures priority forwarding of high demand data packets

DSW series unmanaged switch





DSW-A3K



DSW-A5K



DSW-A8K

Features

- Industrial-grade Chip.
- 10/100/1000 BaseT(X)(RJ45 connector) .
- Compact size for easy installation.
- Broadcast storm protection (BSP),the Quality of Service (QoS) function.
- Die-casting aluminum alloy housing.
- IP30 protection class.
- -40 to 75°C wide operating temperature range.

Specifications

Type	DSW-A5K0005	DSW-A8K0008	DSW-A3K1020	DSW-A5K0050	DSW-A8K0080	DSW-A5K0104	DSW-A8K0206	DSW-A8K0107
Ports	5 BaseT ports	8 BaseT ports	1BaseX SFP port 2 BaseT ports	5 BaseT ports	8 BaseT ports	1 BaseX SFP port 4 BaseT ports	2 BaseX SFP port 6 BaseT ports	1 BaseX SFP port 7 BaseT ports
Bandwidth	100M	100M	1000M	1000M	1000M	100M	100M	100M

Switch Properties

Processing Type	Store-and-Forward
Backplane Bandwidth	16Gbps (Max)
MAC Table Size	4K (Max)
Packet Buffer Size	1.5Mb (Max)

DIP Switch Configuration

	Quality of Service (QoS), Broadcast Storm Protection (BSP)
	Ethernet Interface

Power Parameters

Connection	1 removable 2-contact terminal block
Input Voltage	12/24/48 VDC & 24 VAC
Operating Voltage	9.6~60 VDC & 18~30 VAC
Overload Current Protection	Supported
Reverse Polarity Protection	Supported

Physical Characteristics

Installation	DIN-rail mounting
Housing	Die-casting aluminum alloy housing
(W×H×D) Dimensions	MTX100-A3K/-A5K: 24mm x 100mm x 61.8mm MTX100-A8K: 40mm x 100mm x 61.8mm
Weight	0.23Kg (Max)
Power Consumption	5W(Max)

Environment Limits

Ambient Relative Humidity	5 to 95% (non-condensing)
Operating Temperature	- 40°C~ 75°C
Storage Temperature	- 40°C~ 85°C

Standards and Certifications

Safety	IEC/EN62368-1
FCC	FCC 47 CFR Part 15 Class A
EMC	EN55032 EN55035

DSW series unmanaged switch



RoHS

Overall Dimensions

DSW-A3K/A5K

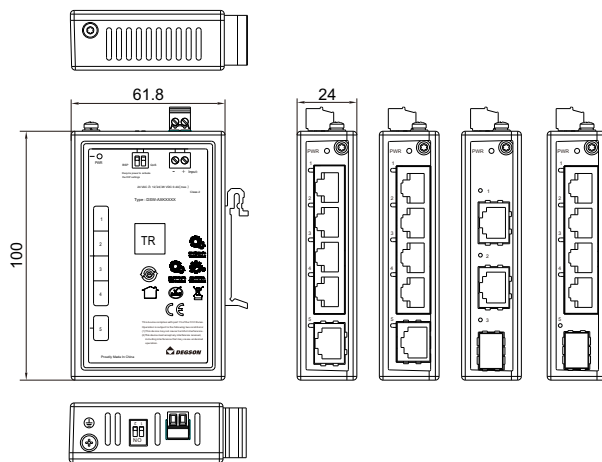

DSW-A8K

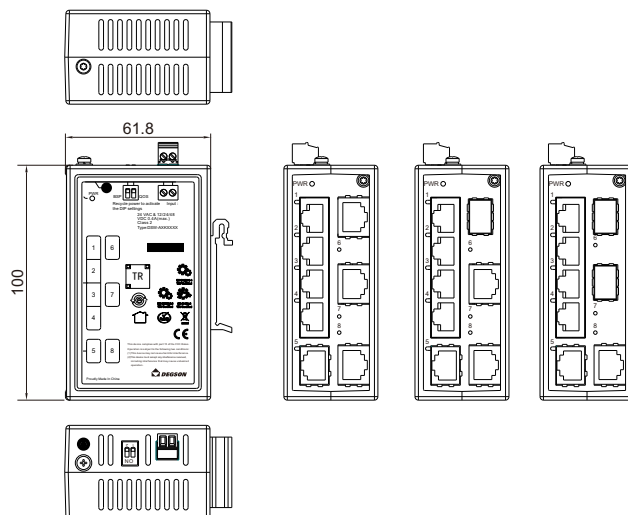

Accessories

Picture	Product	Transmission rate	Transfer mode	Matching model
	DSW-SFP-01-S-20	10/100Mbps	Single mode	DSW-A5K0104 DSW-A8K0107 DSW-A8K0206
	DSW-SFP-10-S-20	100/1000Mbps	Single mode	DSW-A3K1020

DSW series unmanaged switch

CE RoHS



DSW-A16K000G

Features

- Industrial-grade Chips
- Small size, and easy to install
- Support QoS (IEEE 802.1P/1Q and TOS/DiffServ)
- Die-cast aluminum alloy shell
- IP30 protection grade
- Redundant dual input power supply design
- -40 to 75°C wide operating temperature range
- Support DIP sound and light alarm output and 1 relay alarm port (1A@24VDC)

Specifications

Type	DSW-A16K000G
Ports	16 16 BaseT ports
Bandwidth	100M

Switch Properties

Processing Type	Store-and-Forward
Backplane Bandwidth	8.8Gbps (Max)
MAC Table Size	8K (Max)
Packet Buffer Size	4Mb (Max)

DIP Switch Configuration

DIP Switch Function	QoS (Quality of Service), BSP (Broadcast Storm Protection), Power Alarm, Port Alarm, Alarm Buzzer
---------------------	---

Power Parameters

Connection	1 removable 6-contact terminal block
Input Voltage	12/24/48 VDC & 24 VAC, redundant dual input
Operating Voltage	9.6-60 VDC & 18-30 VAC
Overload Current Protection	Supported
Reverse Polarity Protection	Supported
Power Consumption	<10W

Physical Characteristics

Installation	DIN-rail mounting
Housing	Die-casting aluminum alloy housing
IP Grade	IP30
(W×H×D) Dimensions	52mmx140mmx110mm
Weight	<1.2 kg

Environment Limits

Ambient Relative Humidity	5 to 95% (non-condensing)
Operating Temperature	-40°C~ 75°C
Storage Temperature	-40°C~ 85°C

Standards and Certifications

Safety	IEC/EN62368-1
FCC	FCC: FCC 47 CFR Part 15 Class A
EMC	EN55032 EN55035

DSW series unmanaged switch



RoHS

Overall Dimensions

DSW-A16K000G

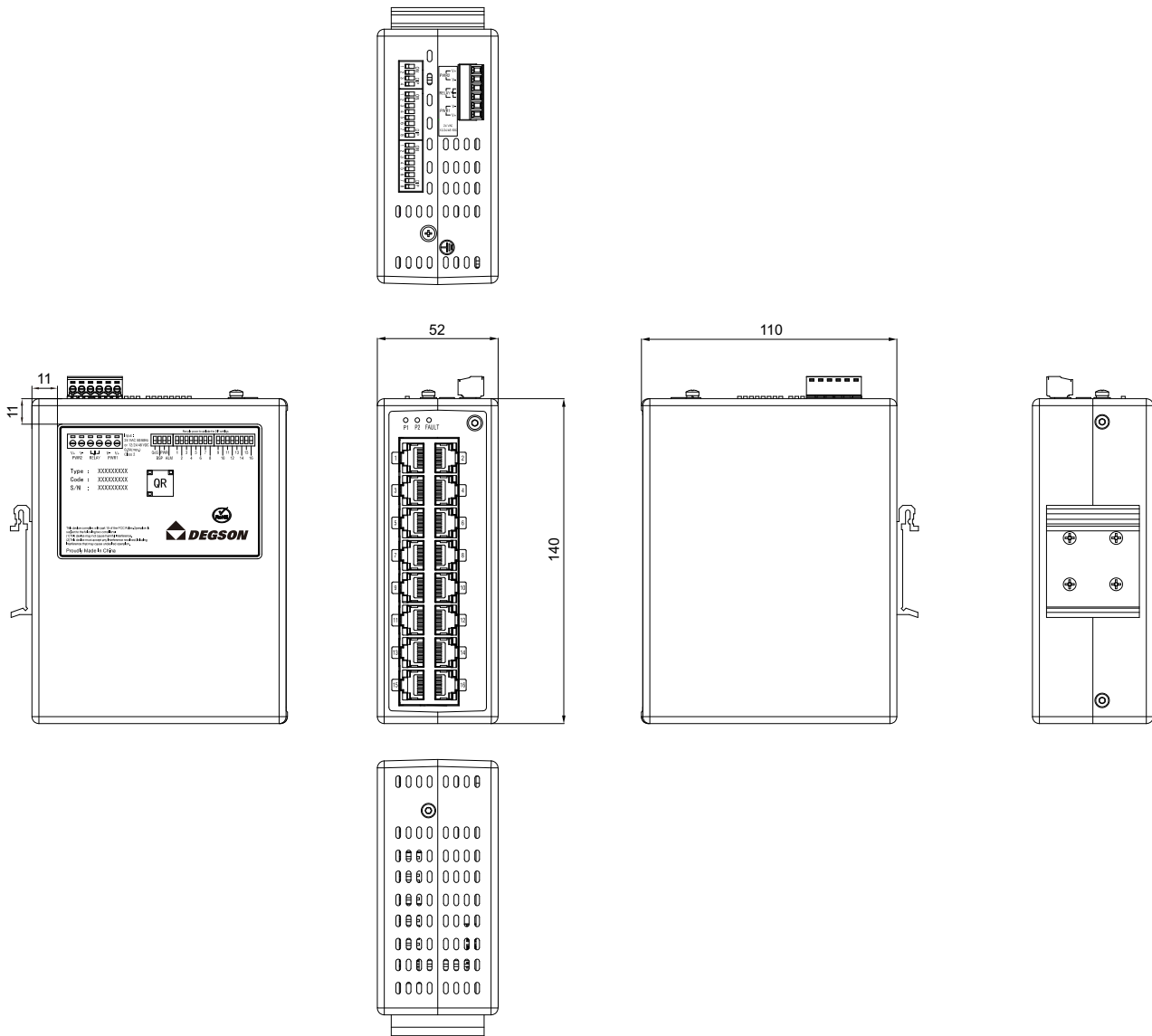

Accessories

Picture	Product	Transmission rate	Transfer mode	Matching model
/	/	/	/	/
/	/	/	/	/

DSW series unmanaged switch





DSW-A6K2040P



DSW-A10K2080P

Features

- Full Gigabit Ethernet ports.
- 20Gbps backplane bandwidth.
- Support IEEE 802.3af/at compliant PoE.
- Each PoE port provides up to 30W output power
- PoE management: PoE device detection, PoE power management.
- Dual redundant power inputs design for DC models.
- IP40 Die-casting aluminum alloy housing.
- Fanless, -40 to 75°C wide operating temperature range.
- MTBF \geq 400,000 hours.

Specifications

Type	DSW-A6K2040P	DSW-A10K2080P
Ports	2 BaseX SFP port, 4 BaseT ports	2 BaseX SFP port, 8 BaseT ports
Bandwidth	1000M	1000M

Switch Properties

Processing Type	Store-and-Forward
Backplane Bandwidth	20Gbps (Max)
MAC Table Size	4K (Max)
Exchange Rate	1,488,000 pps / 1000M ports

Power Parameters

Connection	1 removable 5-contact terminal block
Input Voltage	DSW-A6K/A10K: 48-57VDC, Redundant dual inputs
Overload Current Protection	Supported
Reverse Polarity Protection	Supported

Physical Characteristics

Installation	DIN-rail mounting, Wall mounting
Housing	Die-casting aluminum alloy housing
Protection level	IP30
(W×H×D) Dimensions	52mm×140mm×110mm
Weight	0.7 kg
MTBF	\geq 400,000H

Environment Limits

Ambient Relative Humidity	5 to 95% (non-condensing)
Operating Temperature	-40°C~75°C
Storage Temperature	-40°C~85°C

Electromagnetic Characteristics

EMI	FCC 47 CFR Part 15 Class A EN55022 Class A
-----	--

Standards and Certifications

Safety	FCC Part 15 Subpart B Class A	IEC/EN55022 Class A IEC60825-1
Industrial Control Industry	UL/cUL61010	
Power Industry	IEC61850-3 IEEE1613 (C37.90.x)	

DSW series unmanaged switch



RoHS

Overall Dimensions

DSW-A6K2040P

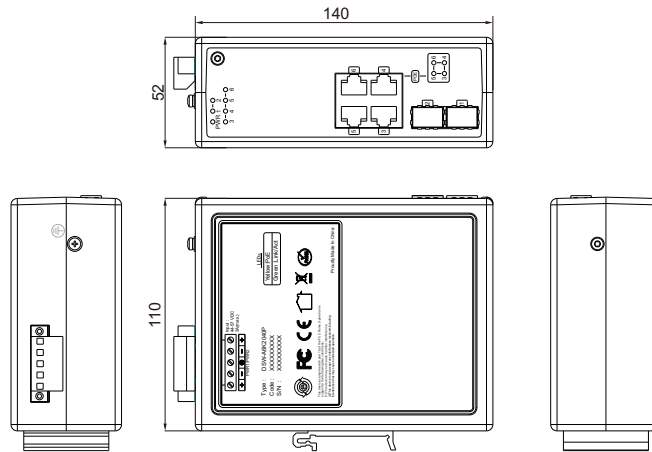

DSW-A10K2080P

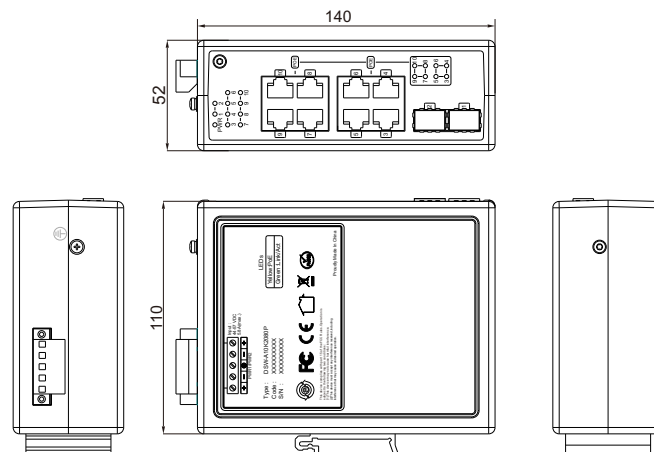

Accessories

Picture	Product	Transmission rate	Transfer mode	Matching model
	DSW-SFP-10-S-20	100/1000Mbps	Single mode	DSW-A6K2040P DSW-A10K2080P
/	/	/	/	/



Features



- Small size, easy to install.
- You can select PNP, NPN according to the function mode of the controller.
- There is LED indicator light, you can see the working status of the product.
- IP67 level of protection.
- You can choose the material and length of the cable.

Product

Product	JB-M8-04-P-00	JB-M8-04-N-00	Product	JB-M8-04-P-00	JB-M8-04-N-00
Functional description	Split Plastic box, 4 channels, single signal, PNP	Split Plastic box, 4 channels, single signal, NPN	Functional description	Split Plastic box, 4 channels, single signal, PNP	Split Plastic box, 4 channels, single signal, NPN
Performance Parameter			I/O Parameters		
Signal type	PNP	NPN	Rated Voltage	24VDC	
Number of i/o channels	4		Rated Current	1.5A	
Number of signal output points	1		Interface type	M8 Female Acode 3P IEC 61076-2-104	
Shell material	PBT		Torque	0.2Nm(1.77Lb-In)	
Contact Material	Copper alloy		Interface material	Copper alloy	
Contact surface material	Au		Thread material	Ni	
Contact Material	PA		Mechanical Structure		
Contact Resistance	<10mΩ		Protection grade	IP67	
Power Supply Parameters			size(L X W X H)	86.6mm X 30.6mm X 27mm	
Supply Voltage	10...30VDC		Work Environment		
Supply Current MAX	Max 4A		Working temperature	-25...80°C	
Interface type	M12 Male Acode 8P IEC 61076-2-101		Storage temperature	-25...80°C	
Torque	0.4Nm(3.54Lb-In)		LED Status Indicator		
Interface material	Copper alloy		Power Lamp	Green LED	
Thread material	Ni		I/O Lamp	Yellow LED	

JB Series Junction Box

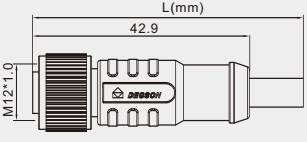
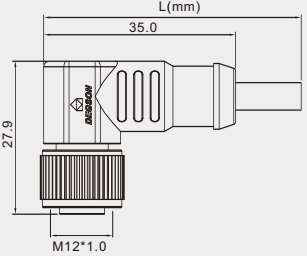
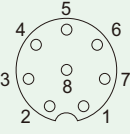
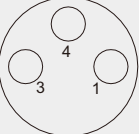
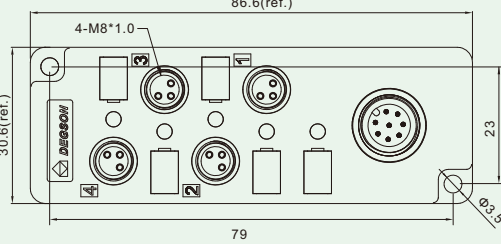
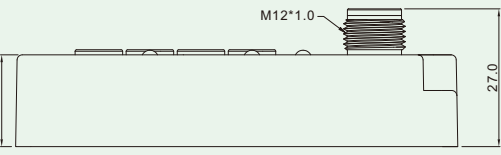
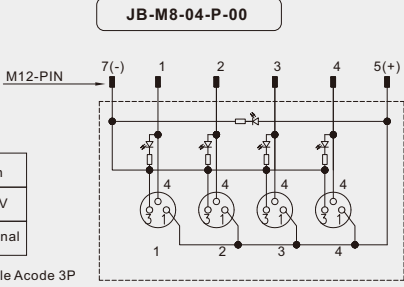
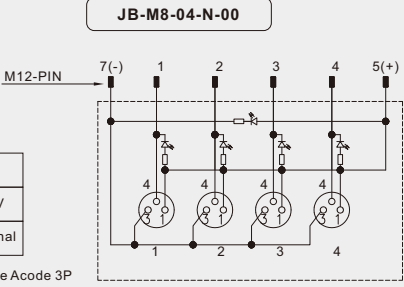

Cable																								
Product	PM-M12A-08P-FF-SL8A02-00A(H)	PM-M12A-08P-FF-SL8B02-00A(H)	PM-M12A-08P-FF-SR8A02-00A(H)	PM-M12A-08P-FF-SR8B02-00A(H)																				
Shell material	M12 * 1 Female Overmolded with Cable Plug, 8P, single end, Unshielded, Straight, PVC, 2m	M12 * 1 Female Overmolded with Cable Plug, 8P, single end, Unshielded, Straight, PUR, 2m	M12 * 1 Female Overmolded with Cable Plug, 8P, single end, Unshielded, Angled, PVC, 2m	M12 * 1 Female Overmolded with Cable Plug, 8P, single end, Unshielded, Angled, PUR, 2m																				
Cable																								
M12 Connector Pin drawing	 <p>M12 Female Acode 8P</p>		<table border="1"> <thead> <tr> <th>NO.</th> <th>Color</th> <th>NO.</th> <th>Color</th> </tr> </thead> <tbody> <tr> <td>1</td> <td>White(WH)</td> <td>5</td> <td>Grey(GY)</td> </tr> <tr> <td>2</td> <td>Brown(BN)</td> <td>6</td> <td>Pink(PK)</td> </tr> <tr> <td>3</td> <td>Green(GN)</td> <td>7</td> <td>Blue(BU)</td> </tr> <tr> <td>4</td> <td>Yellow(YE)</td> <td>8</td> <td>Red(RD)</td> </tr> </tbody> </table>		NO.	Color	NO.	Color	1	White(WH)	5	Grey(GY)	2	Brown(BN)	6	Pink(PK)	3	Green(GN)	7	Blue(BU)	4	Yellow(YE)	8	Red(RD)
NO.	Color	NO.	Color																					
1	White(WH)	5	Grey(GY)																					
2	Brown(BN)	6	Pink(PK)																					
3	Green(GN)	7	Blue(BU)																					
4	Yellow(YE)	8	Red(RD)																					
M8 Pin drawing	 <p>M8 Female Acode 3P</p>																							
Junction Box drawing																								
Wiring Diagram	<p>JB-M8-04-P-00</p>  <table border="1"> <tr><td>1</td><td>Un</td></tr> <tr><td>3</td><td>0 V</td></tr> <tr><td>4</td><td>Signal</td></tr> </table> <p>M8 Female Acode 3P</p>		1	Un	3	0 V	4	Signal	<p>JB-M8-04-N-00</p>  <table border="1"> <tr><td>1</td><td>Un</td></tr> <tr><td>3</td><td>0 V</td></tr> <tr><td>4</td><td>Signal</td></tr> </table> <p>M8 Female Acode 3P</p>		1	Un	3	0 V	4	Signal								
1	Un																							
3	0 V																							
4	Signal																							
1	Un																							
3	0 V																							
4	Signal																							



Features



- Small size, easy to install.
- You can select PNP, NPN according to the function mode of the controller.
- There is LED indicator light, you can see the working status of the product.
- IP67 level of protection.
- You can choose the material and length of the cable.

Product

Product	JB-M8-06-P-00	JB-M8-06-N-00	Product	JB-M8-06-P-00	JB-M8-06-N-00
Functional description	Split Plastic box, 6 channels, single signal, PNP	Split Plastic box, 6 channels, single signal, PNP	Functional description	Split Plastic box, 6 channels, single signal, PNP	Split Plastic box, 6 channels, single signal, PNP
Performance Parameter			I/O Parameters		
Signal type	PNP	NPN	Rated Voltage	24VDC	
Number of i/o channels	6		Rated Current	1.5A	
Number of signal output points	1		Interface type	M8 Female Acode 3P IEC 61076-2-104	
Shell material	PBT		Torque	0.2Nm(1.77Lb-In)	
Contact Material	Copper alloy		Interface material	Copper alloy	
Contact surface material	Au		Thread material	Ni	
Contact Material	PA		Mechanical Structure		
Contact Resistance	<10mΩ		Protection grade	IP67	
Power Supply Parameters			size(L X W X H)	106.6mm X 30.6mm X 27mm	
Supply Voltage	10...30VDC		Work Environment		
Supply Current MAX	Max 4A		Working temperature	-25...80°C	
Interface type	M12 Male Acode 8P IEC 61076-2-101		Storage temperature	-25...80°C	
Torque	0.4Nm(3.54Lb-In)		LED Status Indicator		
Interface material	Copper alloy		Power Lamp	Green LED	
Thread material	Ni		I/O Lamp	Yellow LED	

JB Series Junction Box

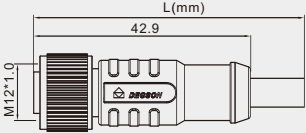
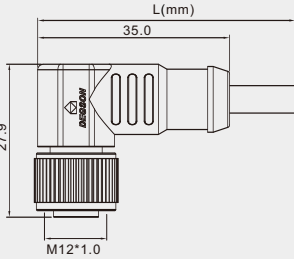
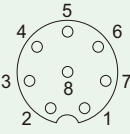
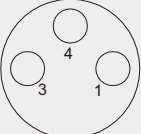
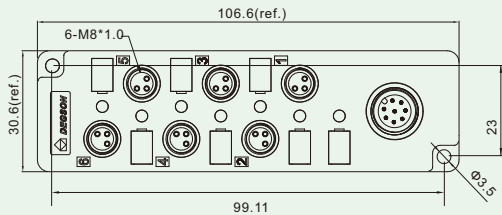
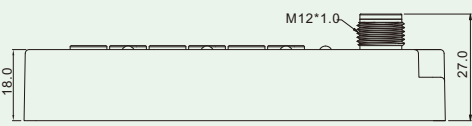
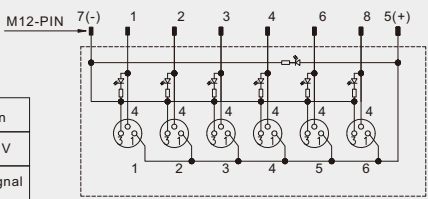
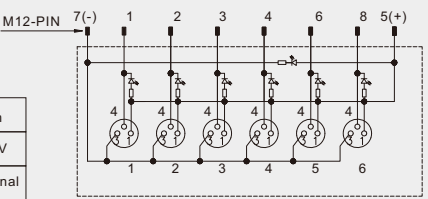

Cable																								
Product	PM-M12A-08P-FF-SL8A02-00A(H)	PM-M12A-08P-FF-SL8B02-00A(H)	PM-M12A-08P-FF-SR8A02-00A(H)	PM-M12A-08P-FF-SR8B02-00A(H)																				
Shell material	M12 * 1 Female Overmolded with Cable Plug, 8P, single end, Unshielded, Straight, PVC, 2m	M12 * 1 Female Overmolded with Cable Plug, 8P, single end, Unshielded, Straight, PUR, 2m	M12 * 1 Female Overmolded with Cable Plug, 8P, single end, Unshielded, Angled, PVC, 2m	M12 * 1 Female Overmolded with Cable Plug, 8P, single end, Unshielded, Angled, PUR, 2m																				
Cable																								
M12 Connector Pin drawing	 <p>M12 Female Acode 8P</p>		<table border="1"> <thead> <tr> <th>NO.</th> <th>Color</th> <th>NO.</th> <th>Color</th> </tr> </thead> <tbody> <tr> <td>1</td> <td>White(WH)</td> <td>5</td> <td>Grey(GY)</td> </tr> <tr> <td>2</td> <td>Brown(BN)</td> <td>6</td> <td>Pink(PK)</td> </tr> <tr> <td>3</td> <td>Green(GN)</td> <td>7</td> <td>Blue(BU)</td> </tr> <tr> <td>4</td> <td>Yellow(YE)</td> <td>8</td> <td>Red(RD)</td> </tr> </tbody> </table>		NO.	Color	NO.	Color	1	White(WH)	5	Grey(GY)	2	Brown(BN)	6	Pink(PK)	3	Green(GN)	7	Blue(BU)	4	Yellow(YE)	8	Red(RD)
NO.	Color	NO.	Color																					
1	White(WH)	5	Grey(GY)																					
2	Brown(BN)	6	Pink(PK)																					
3	Green(GN)	7	Blue(BU)																					
4	Yellow(YE)	8	Red(RD)																					
M8 Pin drawing	 <p>M8 Female Acode 3P</p>																							
Junction Box drawing																								
Wiring Diagram	<p>JB-M8-06-P-00</p>  <table border="1"> <tr><td>1</td><td>Un</td></tr> <tr><td>3</td><td>0 V</td></tr> <tr><td>4</td><td>Signal</td></tr> </table> <p>M8 Female Acode 3P</p>		1	Un	3	0 V	4	Signal	<p>JB-M8-06-N-00</p>  <table border="1"> <tr><td>1</td><td>Un</td></tr> <tr><td>3</td><td>0 V</td></tr> <tr><td>4</td><td>Signal</td></tr> </table> <p>M8 Female Acode 3P</p>		1	Un	3	0 V	4	Signal								
1	Un																							
3	0 V																							
4	Signal																							
1	Un																							
3	0 V																							
4	Signal																							



Features





- Small size, easy to install.
- You can select PNP, NPN according to the function mode of the controller.
- There is LED indicator light, you can see the working status of the product.
- IP67 level of protection.
- You can choose the material and length of the cable.

Product

Product	JB-M8-08-P-00	JB-M8-08-N-00	Product	JB-M8-08-P-00	JB-M8-08-N-00
Functional description	Split Plastic box, 8 channels, single signal, PNP	Split Plastic box, 8 channels, single signal, NPN	Functional description	Split Plastic box, 8 channels, single signal, PNP	Split Plastic box, 8 channels, single signal, NPN
Performance Parameter			I/O Parameters		
Signal type	PNP	NPN	Rated Voltage	24VDC	
Number of i/o channels	8		Rated Current	1.5A	
Number of signal output points	1		Interface type	M8 Female Acode 3P IEC 61076-2-104	
Shell material	PBT		Torque	0.2Nm(1.77Lb-In)	
Contact Material	Copper alloy		Interface material	Copper alloy	
Contact surface material	Au		Thread material	Ni	
Contact Material	PA		Mechanical Structure		
Contact Resistance	<10mΩ		Protection grade	IP67	
Power Supply Parameters			size(L X W X H)	126.6mm X 30.6mm X 27mm	
Supply Voltage	10...30VDC		Work Environment		
Supply Current MAX	Max 4A		Working temperature	-25...80°C	
Interface type	M12 Male Acode 12P IEC 61076-2-101		Storage temperature	-25...80°C	
Torque	0.4Nm(3.54Lb-In)		LED Status Indicator		
Interface material	Copper alloy		Power Lamp	Green LED	
Thread material	Ni		I/O Lamp	Yellow LED	

JB Series Junction Box

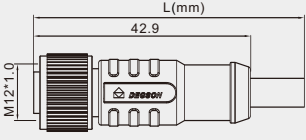
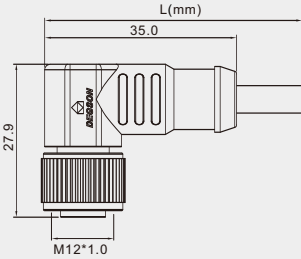
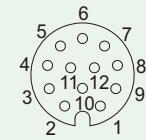
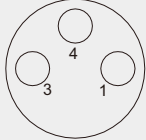
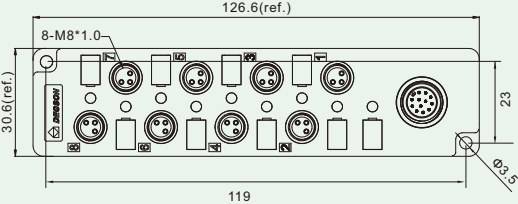

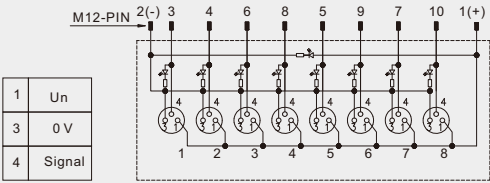
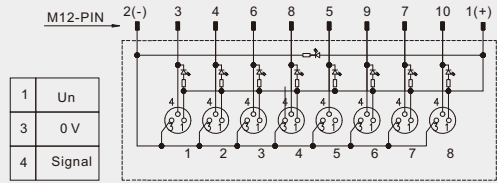
Cable																																
Product	PM-M12A-12P-FF-SL8A03-00A(H)	PM-M12A-12P-FF-SL8B03-00A(H)	PM-M12A-12P-FF-SR8A03-00A(H)	PM-M12A-12P-FF-SR8B03-00A(H)																												
Shell material	M12 * 1 Female Overmolded with Cable Plug, 12P, single end, Unshielded, Straight, PVC, 3m	M12 * 1 Female Overmolded with Cable Plug, 12P, single end, Unshielded, Straight, PUR, 3m	M12 * 1 Female Overmolded with Cable Plug, 12P, single end, Unshielded, Angled, PVC, 3m	M12 * 1 Female Overmolded with Cable Plug, 12P, single end, Unshielded, Angled, PUR, 3m																												
Cable																																
M12 Connector Pin drawing	 <p>M12 Female Acode 12P</p>		<table border="1"> <thead> <tr> <th>NO.</th> <th>Color</th> <th>NO.</th> <th>Color</th> </tr> </thead> <tbody> <tr> <td>1</td> <td>Brown(BN)</td> <td>7</td> <td>Black (BK)</td> </tr> <tr> <td>2</td> <td>Blue(BU)</td> <td>8</td> <td>Grey(GY)</td> </tr> <tr> <td>3</td> <td>White(WH)</td> <td>9</td> <td>Red(RD)</td> </tr> <tr> <td>4</td> <td>Green(GN)</td> <td>10</td> <td>Violet(VT)</td> </tr> <tr> <td>5</td> <td>Pink(PK)</td> <td>11</td> <td>Grey/Pink(GY/PK)</td> </tr> <tr> <td>6</td> <td>Yellow(YE)</td> <td>12</td> <td>Red/Blue(RD/BU)</td> </tr> </tbody> </table>		NO.	Color	NO.	Color	1	Brown(BN)	7	Black (BK)	2	Blue(BU)	8	Grey(GY)	3	White(WH)	9	Red(RD)	4	Green(GN)	10	Violet(VT)	5	Pink(PK)	11	Grey/Pink(GY/PK)	6	Yellow(YE)	12	Red/Blue(RD/BU)
NO.	Color	NO.	Color																													
1	Brown(BN)	7	Black (BK)																													
2	Blue(BU)	8	Grey(GY)																													
3	White(WH)	9	Red(RD)																													
4	Green(GN)	10	Violet(VT)																													
5	Pink(PK)	11	Grey/Pink(GY/PK)																													
6	Yellow(YE)	12	Red/Blue(RD/BU)																													
M8 Pin drawing	 <p>M8 Female Acode 3P</p>																															
Junction Box drawing																																
Wiring Diagram	<p style="text-align: center;">JB-M8-08-P-00</p>  <p>M8 Female Acode 3P</p>		<p style="text-align: center;">JB-M8-08-N-00</p>  <p>M8 Female Acode 3P</p>																													



Features

- Small size, easy to install.
- You can select PNP, NPN according to the function mode of the controller.
- There is LED indicator light, you can see the working status of the product.
- IP67 level of protection.
- You can choose the material and length of the cable.

Product

Product	JB-M8-10-P-00	JB-M8-10-N-00	Product	JB-M8-10-P-00	JB-M8-10-N-00
Functional description	Split Plastic box, 10 channels, single signal, PNP	Split Plastic box, 10 channels, single signal, PNP	Functional description	Split Plastic box, 10 channels, single signal, PNP	Split Plastic box, 10 channels, single signal, PNP
Performance Parameter			I/O Parameters		
Signal type	PNP	NPN	Rated Voltage	24VDC	
Number of i/o channels	10		Rated Current	1.5A	
Number of signal output points	1		Interface type	M8 Female Acode 3P IEC 61076-2-104	
Shell material	PBT		Torque	0.2Nm(1.77Lb-In)	
Contact Material	Copper alloy		Interface material	Copper alloy	
Contact surface material	Au		Thread material	Ni	
Contact Material	PA		Mechanical Structure		
Contact Resistance	<10mΩ		Protection grade	IP67	
Power Supply Parameters			size(L X W X H)	146.6mm X 30.6mm X 27mm	
Supply Voltage	10...30VDC		Work Environment		
Supply Current MAX	Max 4A		Working temperature	-25...80°C	
Interface type	M12 Male Acode 12P IEC 61076-2-101		Storage temperature	-25...80°C	
Torque	0.4Nm(3.54Lb-In)		LED Status Indicator		
Interface material	Copper alloy		Power Lamp	Green LED	
Thread material	Ni		I/O Lamp	Yellow LED	

JB Series Junction Box CE RoHS

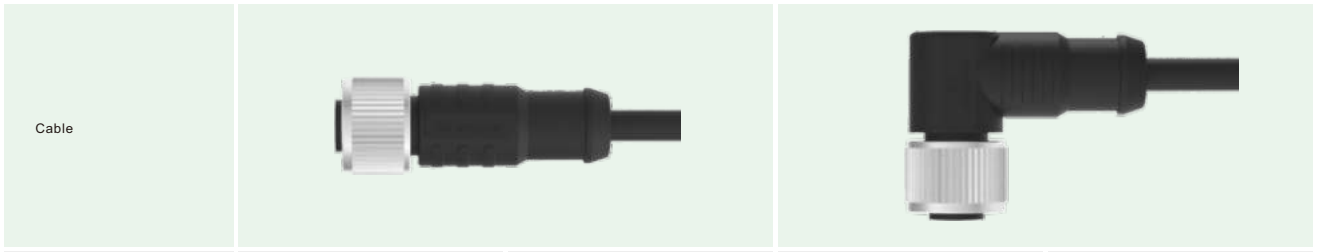

Product	PM-M12A-12P-FF-SL8A02-00A(H)	PM-M12A-12P-FF-SL8B02-00A(H)	PM-M12A-12P-FF-SR8A02-00A(H)	PM-M12A-12P-FF-SR8B02-00A(H)
Shell material	M12 * 1 Female Overmolded with Cable Plug, 12P, single end, Unshielded, Straight, PVC, 3m	M12 * 1 Female Overmolded with Cable Plug, 12P, single end, Unshielded, Straight, PUR, 3m	M12 * 1 Female Overmolded with Cable Plug, 12P, single end, Unshielded, Angled, PVC, 3m	M12 * 1 Female Overmolded with Cable Plug, 12P, single end, Unshielded, Angled, PUR, 3m

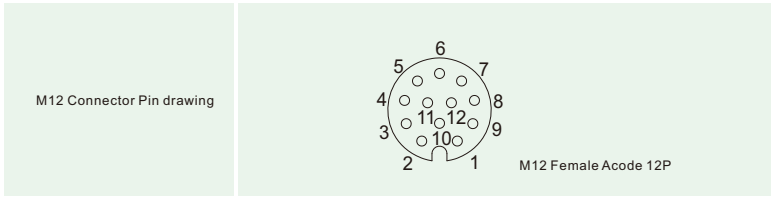
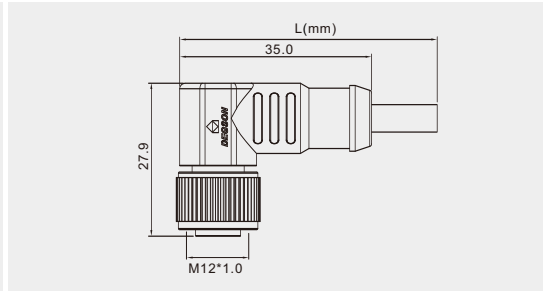
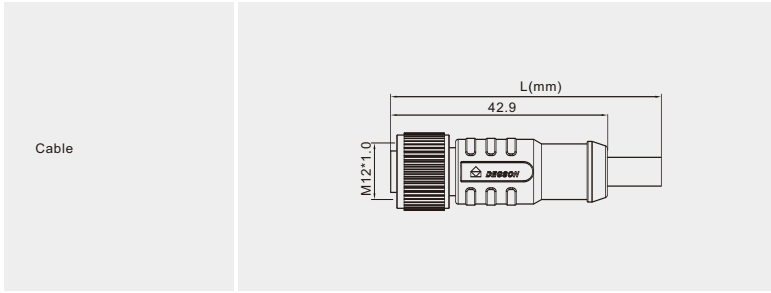

NO.	Color	NO.	Color
1	Brown(BN)	7	Black (BK)
2	Blue(BU)	8	Grey(GY)
3	White(WH)	9	Red(RD)
4	Green(GN)	10	Violet(VT)
5	Pink(PK)	11	Grey/Pink(GY/PK)
6	Yellow(YE)	12	Red/Blue(RD/BU)

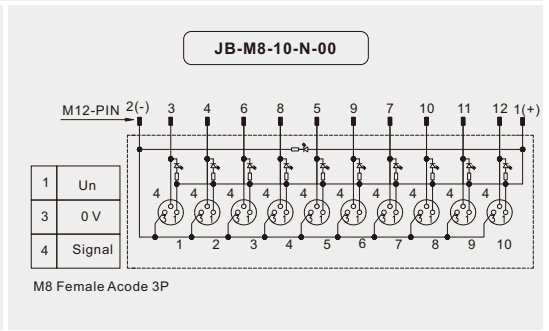
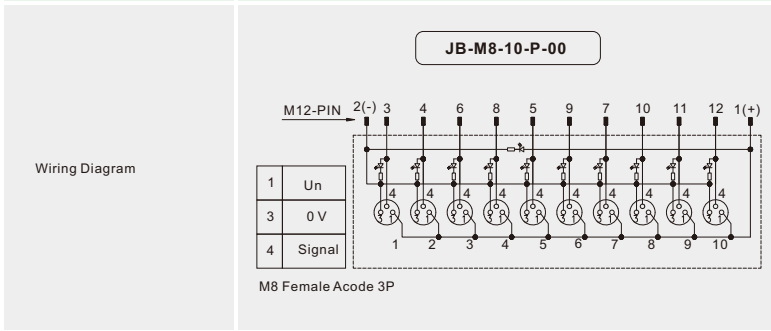
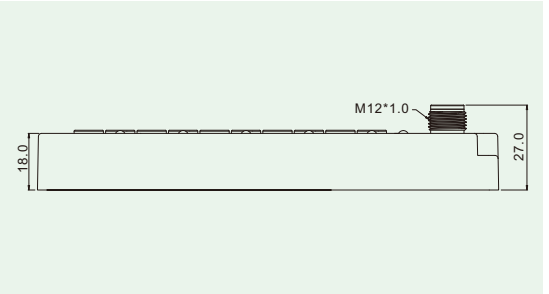
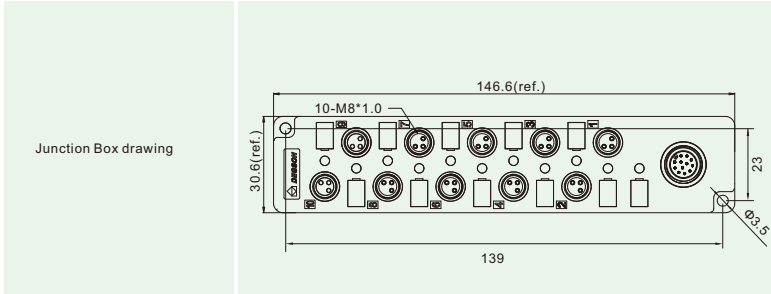
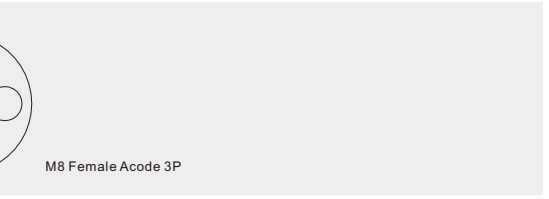
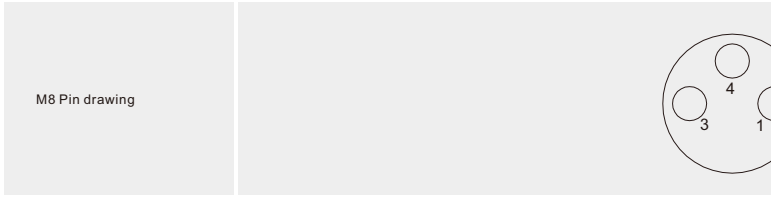



Features

- Small size, easy to install.
- You can select PNP, NPN according to the function mode of the controller.
- There is LED indicator light, you can see the working status of the product.
- IP67 level of protection.
- You can choose the material and length of the cable.

Product

Product	JB-M8-04-P-A03-00	JB-M8-04-N-A03-00
Functional description	Pre-injected cable, plastic box, 4 channels, single signal, PNP, PVC, 3m	Pre-injected cable, plastic box, 4 channels, single signal, NPN, PVC, 3m

Performance Parameter

Signal type	PNP	NPN
Number of i/o channels	4	
Number of signal output points	1	
Shell material	PBT	
Contact Material	Copper alloy	
Contact surface material	Au	
Contact Material	PA	
Contact Resistance	<10mΩ	
Cable material	PUR/PP, 5 million times	
Cable length	3m	

Power Supply Parameters

Supply Voltage	10...30VDC
Supply Current MAX	Max 4A

I/O Parameters

Rated Voltage	24VDC
Rated Current	1.5A
Interface type	M8 Female Acode 3P IEC 61076-2-104
Torque	0.2Nm(1.77Lb-In)
Interface material	Copper alloy
Thread material	Ni

JB Series Junction Box CE RoHS

Mechanical Structure

Protection grade	IP67
size(L X W X H)	86.6mm X 30.6mm X 18mm

Work Environment

Working temperature	-25...80°C
Storage temperature	-25...80°C

LED Status Indicator

Power Lamp	Green LED
I/O Lamp	Yellow LED

Product Figure

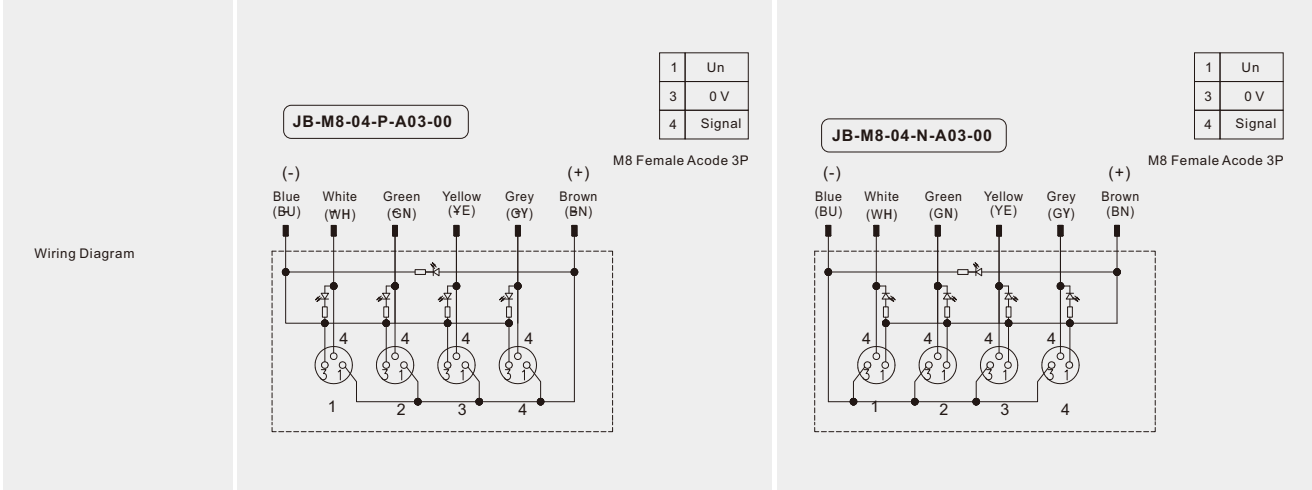
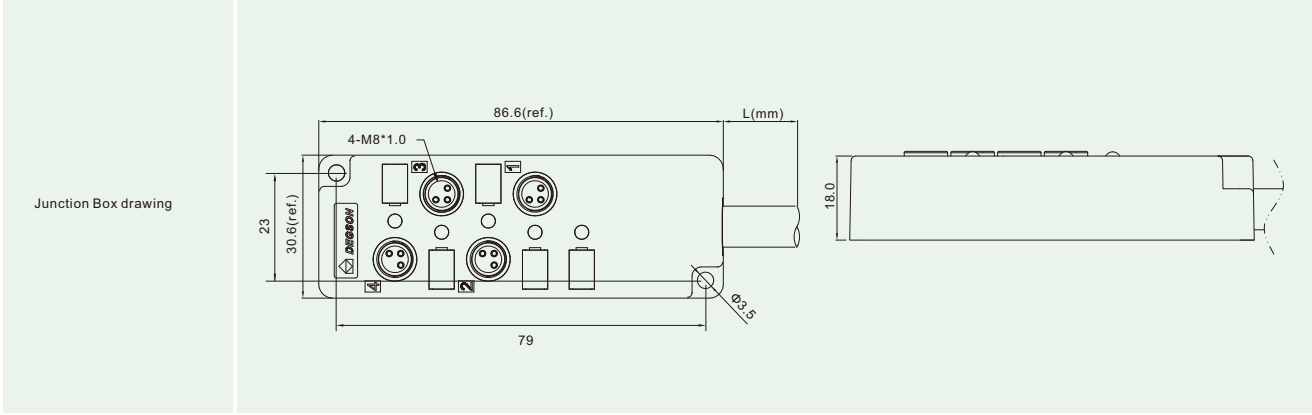
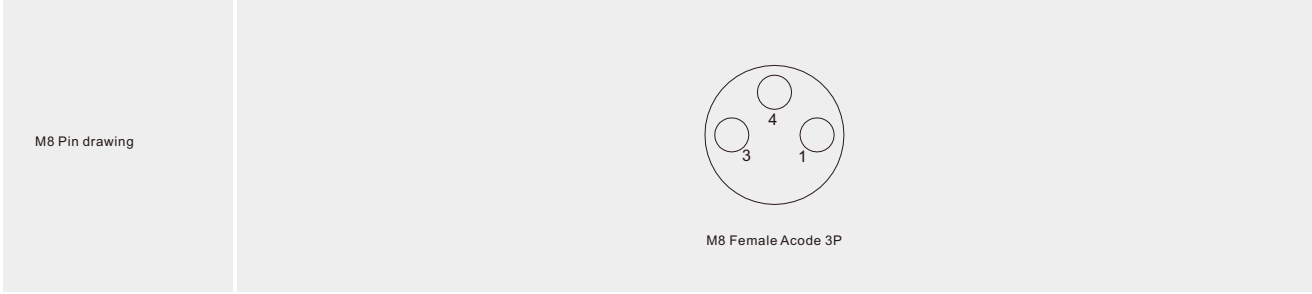



Features

- Small size, easy to install.
- You can select PNP, NPN according to the function mode of the controller.
- There is LED indicator light, you can see the working status of the product.
- IP67 level of protection.
- You can choose the material and length of the cable.

Product

Product	JB-M8-06-P-A03-00	JB-M8-06-N-A03-00
Functional description	Pre-injected cable, plastic box, 6 channels, single signal, PNP, PVC, 3m	Pre-injected cable, plastic box, 6 channels, single signal, NPN, PVC, 3m

Performance Parameter

Signal type	PNP	NPN
Number of i/o channels	6	
Number of signal output points	1	
Shell material	PBT	
Contact Material	Copper alloy	
Contact surface material	Au	
Contact Material	PA	
Contact Resistance	<10mΩ	
Cable material	PUR/PP, 5 million times	
Cable length	3m	

Power Supply Parameters

Supply Voltage	10...30VDC
Supply Current MAX	Max 4A

I/O Parameters

Rated Voltage	24VDC
Rated Current	1.5A
Interface type	M8 Female Acode 3P IEC 61076-2-104
Torque	0.2Nm(1.77Lb-In)
Interface material	Copper alloy
Thread material	Ni

JB Series Junction Box CE RoHS

Mechanical Structure

Protection grade	IP67
size(L X W X H)	106.6mm X 30.6mm X 18mm

Work Environment

Working temperature	-25...80°C
Storage temperature	-25...80°C

LED Status Indicator

Power Lamp	Green LED
I/O Lamp	Yellow LED

Product Figure

M8 Pin drawing

M8 Female Acode 3P

Junction Box drawing

Wiring Diagram

1	Un
3	0 V
4	Signal

JB-M8-06-P-A03-00 M8 Female Acode 3P

Wiring Diagram

1	Un
3	0 V
4	Signal

JB-M8-06-N-A03-00 M8 Female Acode 3P



Features

- Small size, easy to install.
- You can select PNP, NPN according to the function mode of the controller.
- There is LED indicator light, you can see the working status of the product.
- IP67 level of protection.
- You can choose the material and length of the cable.

Product

Product	JB-M8-08-P-A03-00	JB-M8-08-N-A03-00
Functional description	Pre-injected cable, plastic box, 8 channels, single signal, PNP, PVC, 3m	Pre-injected cable, plastic box, 8 channels, single signal, NPN, PVC, 3m

Performance Parameter

Signal type	PNP	NPN
Number of i/o channels	8	
Number of signal output points	1	
Shell material	PBT	
Contact Material	Copper alloy	
Contact surface material	Au	
Contact Material	PA	
Contact Resistance	<10mΩ	
Cable material	PUR/PP, 5 million times	
Cable length	3m	

Power Supply Parameters

Supply Voltage	10...30VDC
Supply Current MAX	Max 4A

I/O Parameters

Rated Voltage	24VDC
Rated Current	1.5A
Interface type	M8 Female Acode 3P IEC 61076-2-104
Torque	0.2Nm(1.77Lb-In)
Interface material	Copper alloy
Thread material	Ni

JB Series Junction Box CE RoHS

Mechanical Structure

Protection grade	IP67
size(L X W X H)	126.6mm X 30.6mm X 18mm

Work Environment

Working temperature	-25...80°C
Storage temperature	-25...80°C

LED Status Indicator

Power Lamp	Green LED
I/O Lamp	Yellow LED

Product Figure

M8 Pin drawing

M8 Female Acode 3P

Junction Box drawing

Wiring Diagram

1	Un
3	0 V
4	Signal

JB-M8-08-P-A03-00 M8 Female Acode 3P

Wiring Diagram

1	Un
3	0 V
4	Signal

JB-M8-08-N-A03-00 M8 Female Acode 3P



Features

- Small size, easy to install.
- You can select PNP, NPN according to the function mode of the controller.
- There is LED indicator light, you can see the working status of the product.
- IP67 level of protection.
- You can choose the material and length of the cable.

Product

Product	JB-M8-10-P-A03-00	JB-M8-10-N-A03-00
Functional description	Pre-injected cable, plastic box, 10 channels, single signal, PNP, PVC, 3m	Pre-injected cable, plastic box, 10 channels, single signal, NPN, PVC, 3m

Performance Parameter

Signal type	PNP	NPN
Number of i/o channels	10	
Number of signal output points	1	
Shell material	PBT	
Contact Material	Copper alloy	
Contact surface material	Au	
Contact Material	PA	
Contact Resistance	<10mΩ	
Cable material	PUR/PP, 5 million times	
Cable length	3m	

Power Supply Parameters

Supply Voltage	10...30VDC
Supply Current MAX	Max 4A

I/O Parameters

Rated Voltage	24VDC
Rated Current	1.5A
Interface type	M8 Female Acode 3P IEC 61076-2-104
Torque	0.2Nm(1.77Lb-In)
Interface material	Copper alloy
Thread material	Ni

JB Series Junction Box CE RoHS





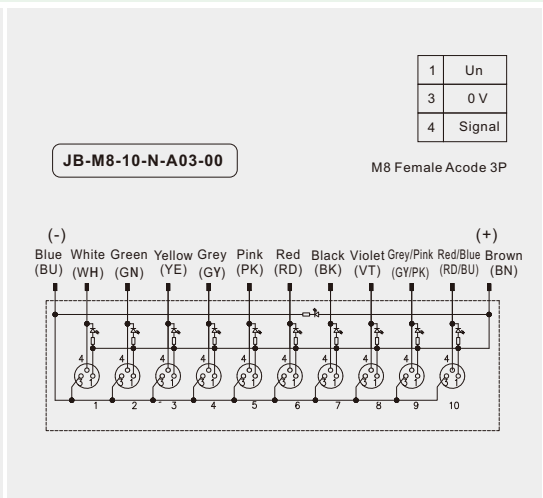
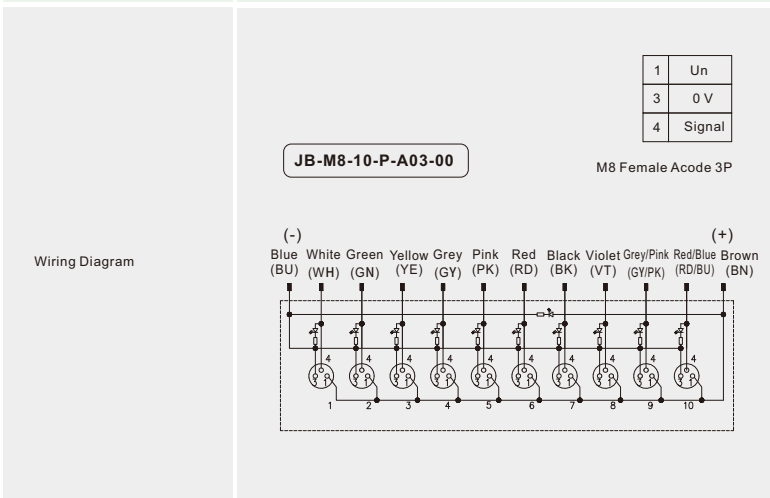
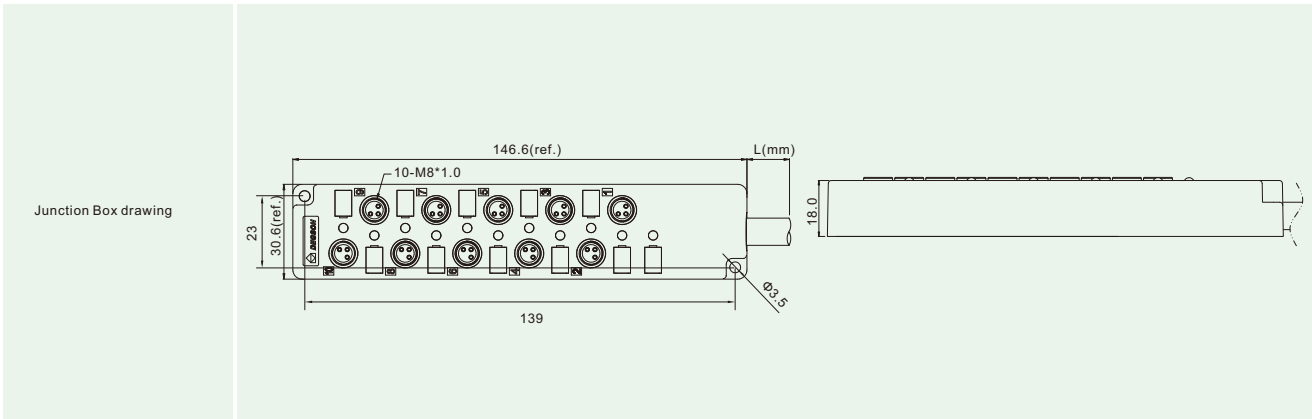
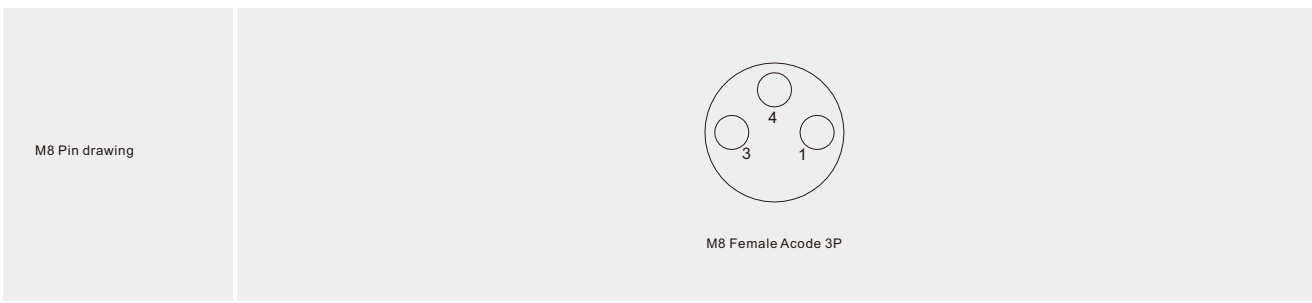

Mechanical Structure	
Protection grade	IP67
size(L X W X H)	146.6mm X 30.6mm X 18mm
Work Environment	
Working temperature	-25...80°C
Storage temperature	-25...80°C
LED Status Indicator	
Power Lamp	Green LED
I/O Lamp	Yellow LED

Product Figure

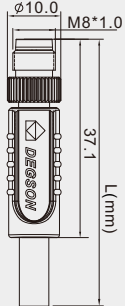
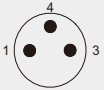

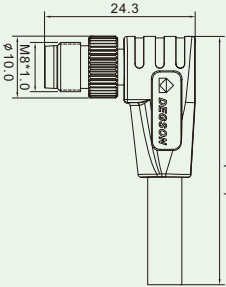
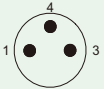
Appendices

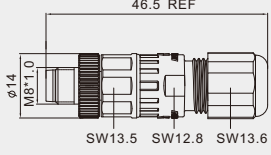
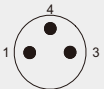

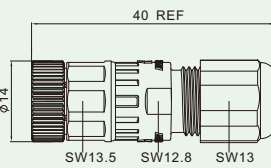
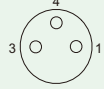







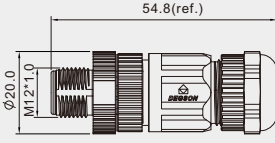

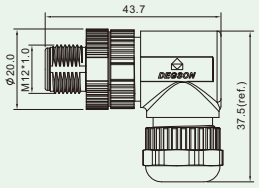
RoHS

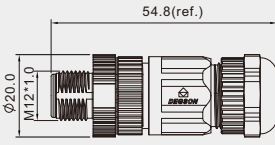
Product	Functional description	Picture	Dimensional drawing	Wiring Diagram	Wiring List
PM-M8A-03P-MM-SL7A02-00A(H)	M12 * 1 Male Overmolded with Cable Plug, 3P, single end, Unshielded, Straight, PVC, 2m				1.BN 3.BU 4.BK
PM-M8A-03P-MM-SL7B02-00A(H)	M12 * 1 Male Overmolded with Cable Plug, 3P, single end, Unshielded, Straight, PUR, 2m				
PM-M8A-03P-MM-SR7A02-00A(H)	M12 * 1 Male Overmolded with Cable Plug, 3P, single end, Unshielded, Angled, PVC, 2m				1.BN 3.BU 4.BK
PM-M8A-03P-MM-SR7B02-00A(H)	M12 * 1 Male Overmolded with Cable Plug, 3P, single end, Unshielded, Angled, PUR, 2m				
PB-M8A-03P-MM-SL7001-00A(H)	M8 * 1 Male Field Assembly Plug, 3P, Unshielded, Screw Connection, Straight				/
PB-M8A-03P-FF-SL7001-00A(H)	M8 * 1 Female Field Assembly Plug, 3P, Unshielded, Screw Connection, Straight				/

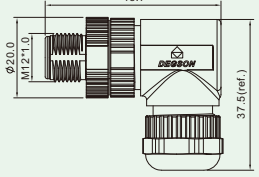
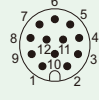
Appendices

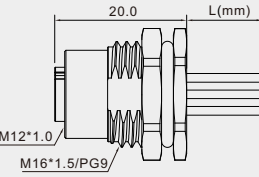
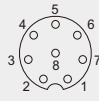

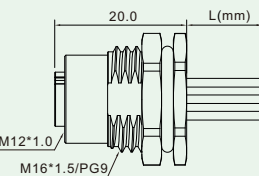
RoHS

Product	Functional description	Picture	Dimensional drawing	Wiring Diagram	Wiring List
PB-M12A-08P-MM-SL7001-00A(H)	M12 * 1 Male Field Assembly Plug, 8P, Unshielded, Screw Connection, Straight				/
PB-M12A-08P-MM-SR7001-00A(H)	M12 * 1 Male Field Assembly Plug, 8P, Unshielded, Screw Connection, Angled				/
PA-M12A-12P-MM-SL7001-00A(H)	M12 * 1 Male Field Assembly Plug, 12P, Unshielded, Soldering Connection, Straight				/
PA-M12A-12P-MM-SR7001-00A(H)	M12 * 1 Male Field Assembly Plug, 12P, Unshielded, Soldering Connection, Angled				/
SD-M12A-08P-FF-SF8AB0-00A(H)	M12 * 1 Female Panel Mount Receptacle, 8P, Rear Mounting, With 2m wires				1.WH 2.BN 3.GN 4.YE 5.GY 6.PK 7.BU 8.RD
PA-M12A-12P-MM-SR7001-00A(H)	M12 * 1 Female Panel Mount Receptacle, 12P, Rear Mounting, With 2m wires				1.BN 2.BU 3.WH 4.GN 5.PK 6.YW 7.BK 8.GY 9.RD 10.VT 11.GY/PK 12.RD/BU

DEGSON Terminal Block

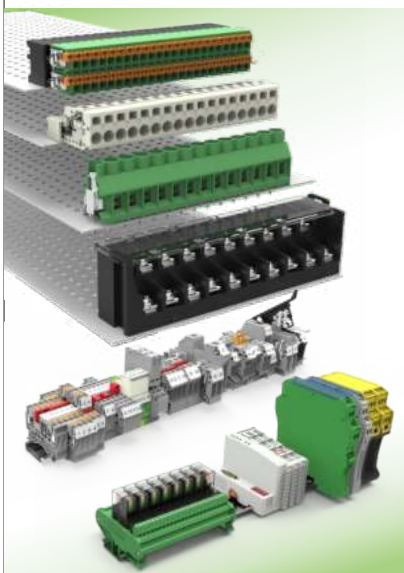

DEGSON ELECTRICAL CO., LTD.
ISO9001 ISO14001 ISO80079-34 ISO/TS22163 IATF16949

DEGSON Circular Connectors



DEGSON ELECTRICAL CO., LTD.
ISO9001 ISO14001 ISO80079-34 ISO/TS22163 IATF16949

DEGSON Heavy Duty Connector



DEGSON ELECTRICAL CO., LTD.
ISO9001 ISO14001 ISO80079-34 ISO/TS22163 IATF16949

DEGSON DIN Rail Terminal Blocks And Accessories System

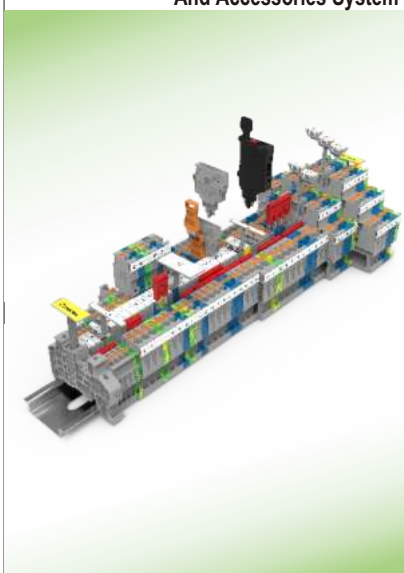

DEGSON ELECTRICAL CO., LTD.
ISO9001 ISO14001 ISO80079-34 ISO/TS22163 IATF16949

DEGSON EV Charging Cable



DEGSON TECHNOLOGY CO.,LTD.
IATF16949

DEGSON Customized Product



DEGSON ELECTRICAL CO., LTD.
ISO9001 ISO14001 ISO80079-34 ISO/TS22163 IATF16949

